

# MODULARO™

## WOODEN SHED TRONDHEIM

2.92 x 2.92 x 2.22 m





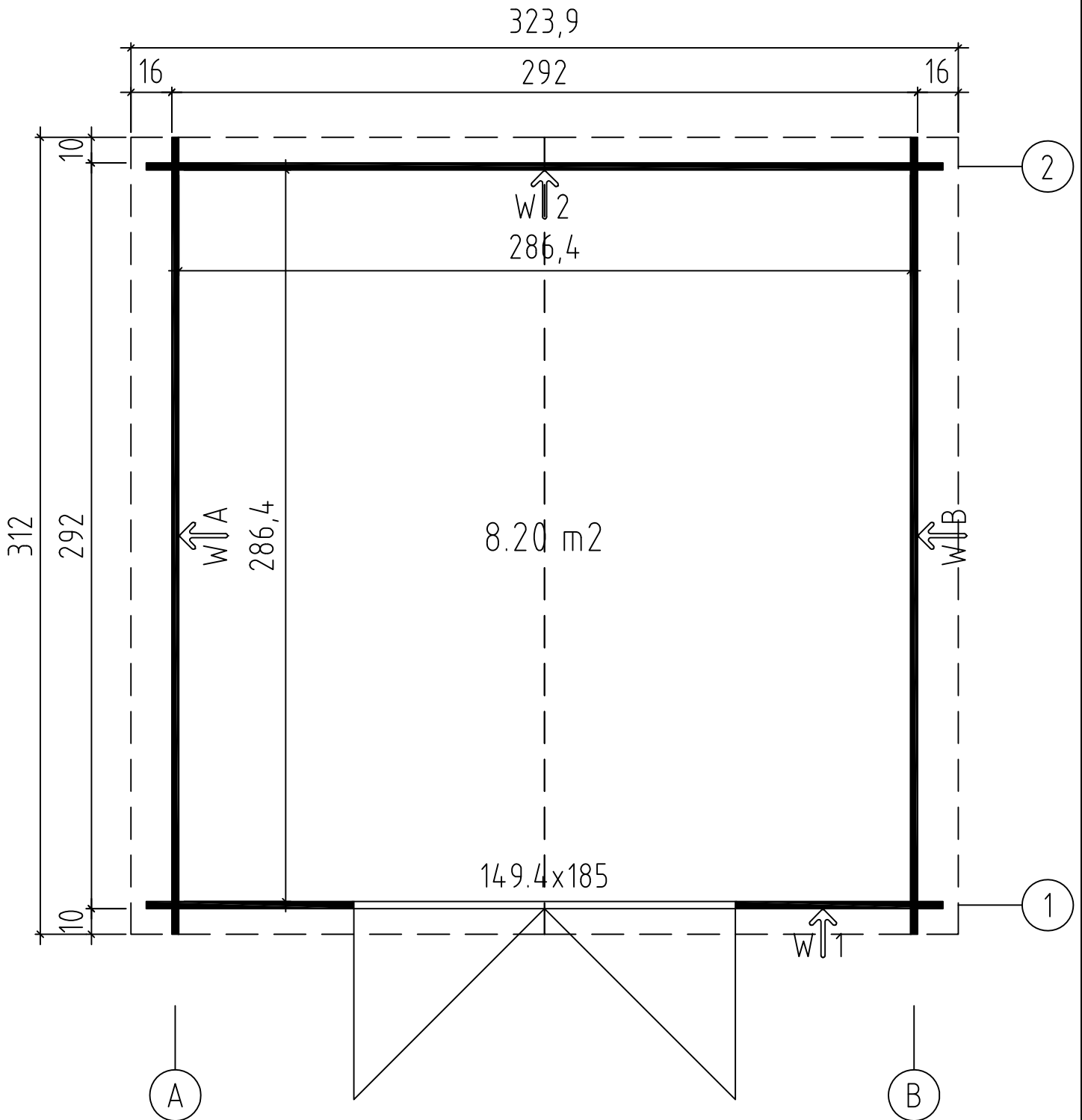

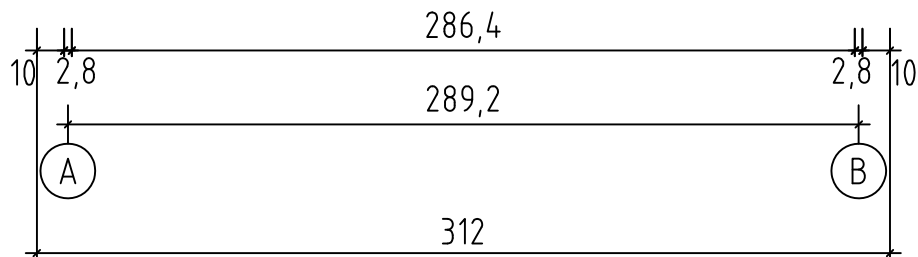
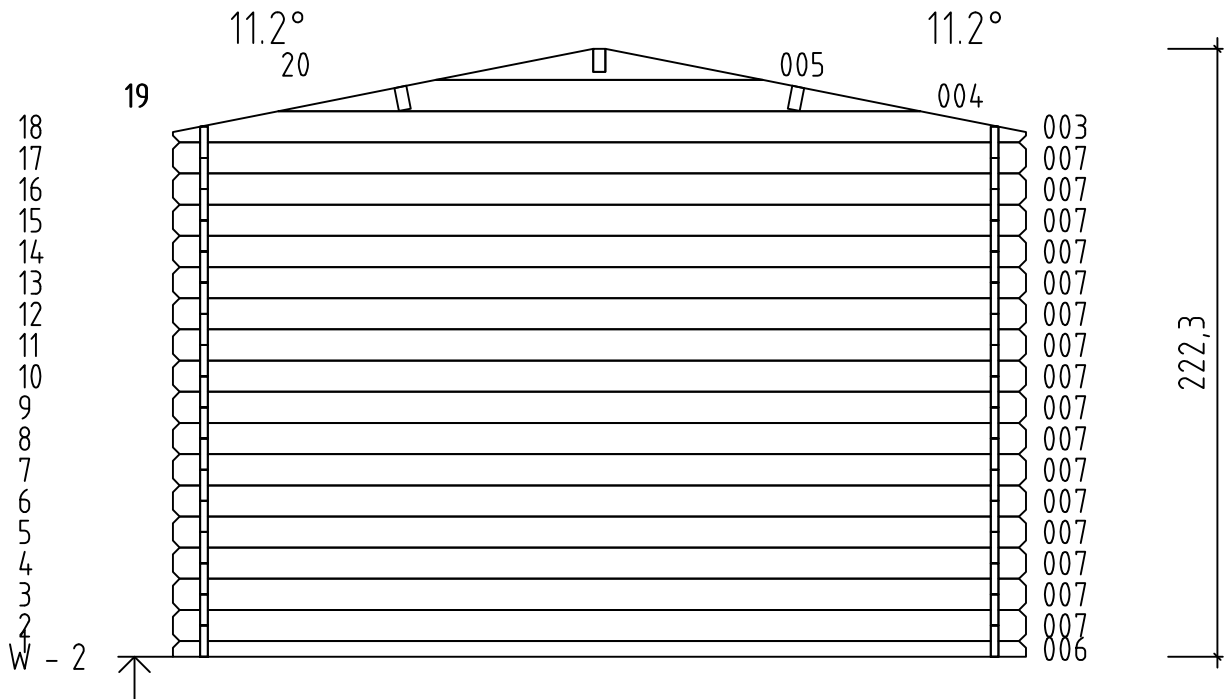
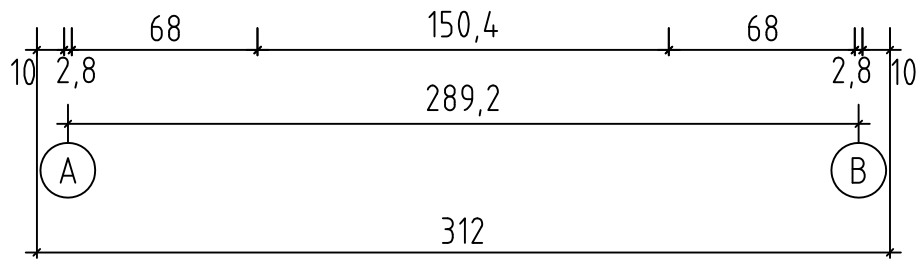
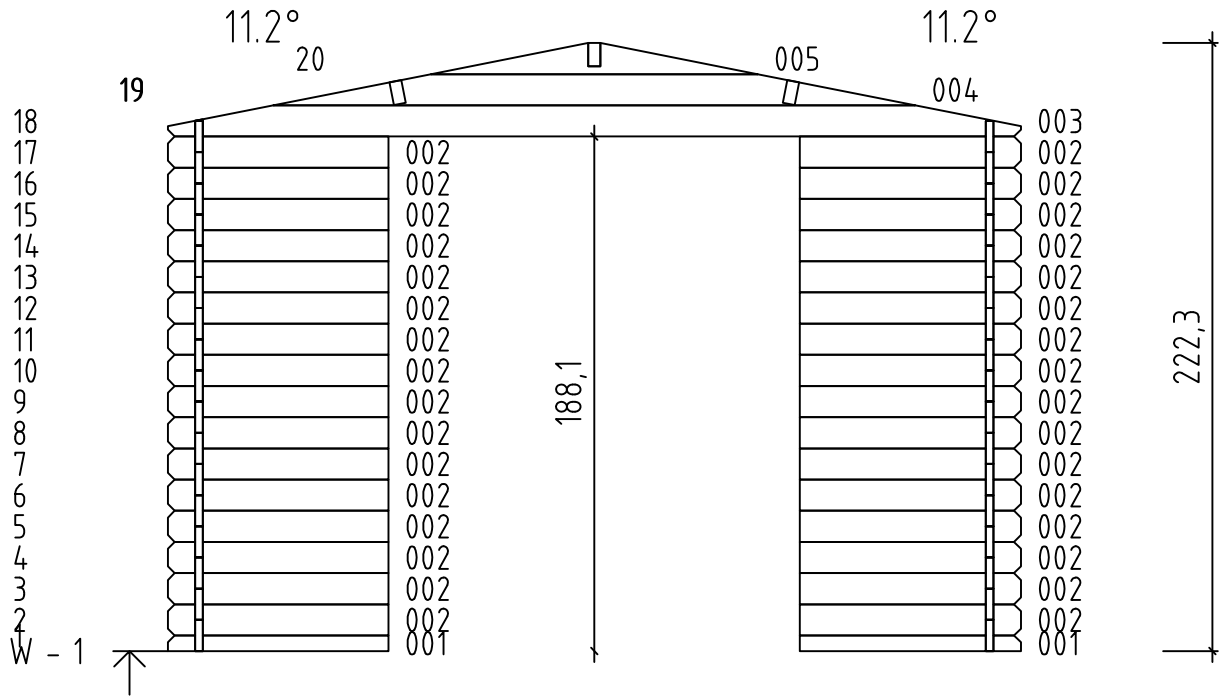

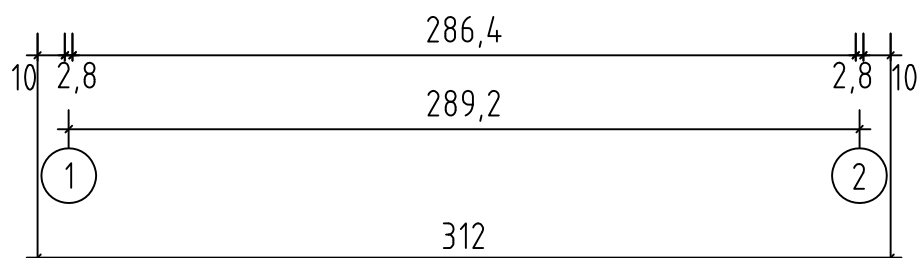
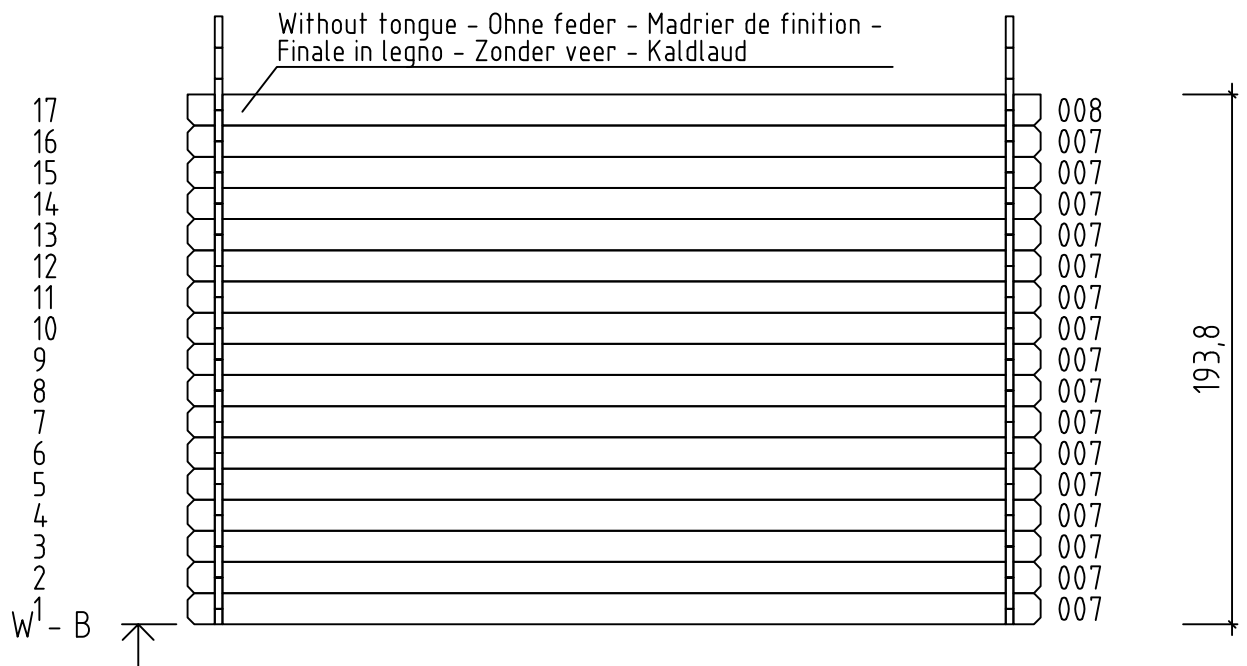
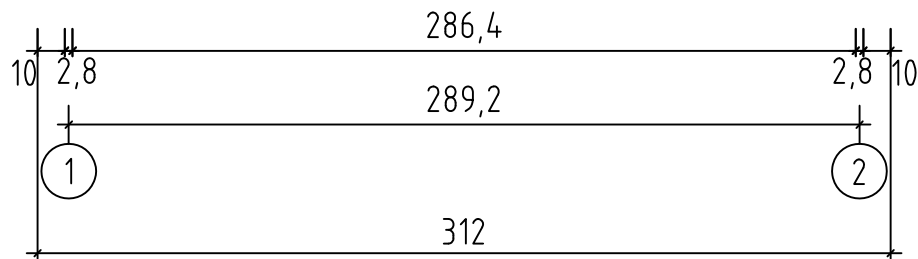
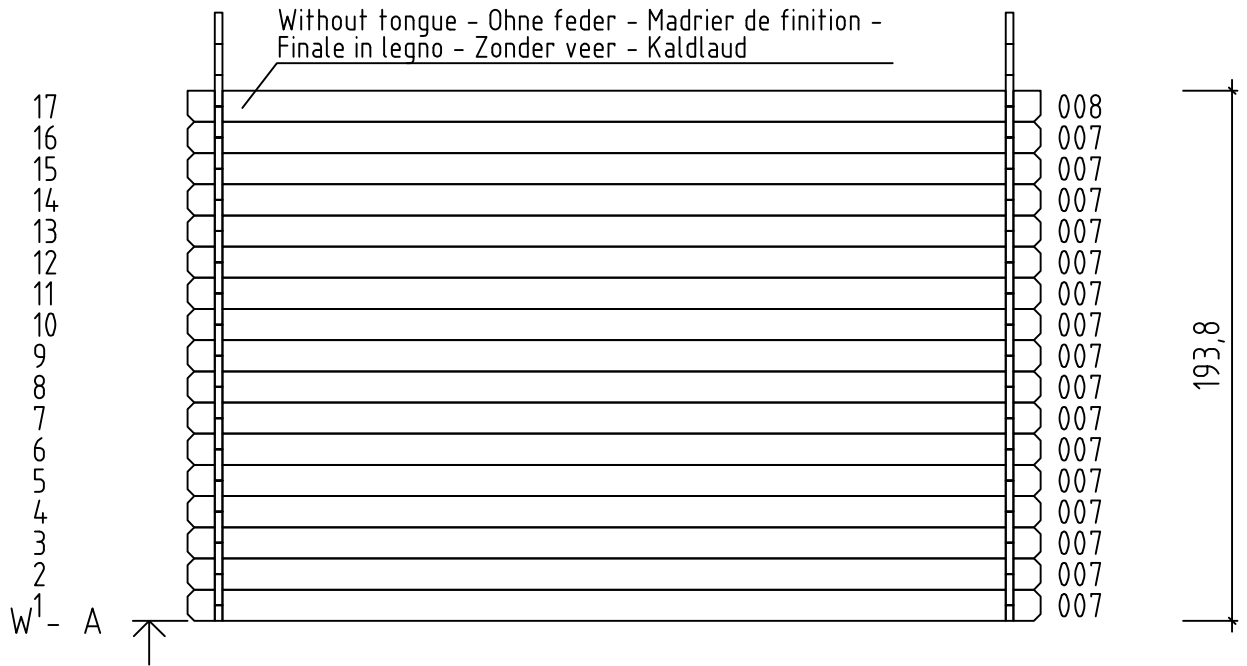

Groundplan - Grundplan - Plan de masse -  
Planimetria - Plattegrond - Põhiplaan

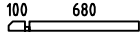
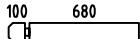
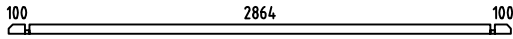
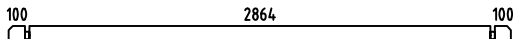
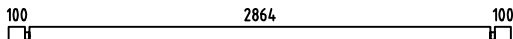
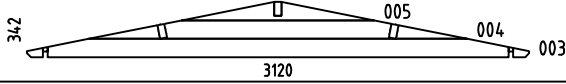
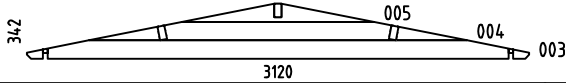
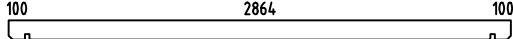

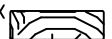
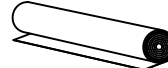
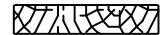
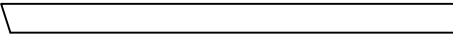
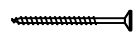

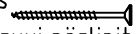

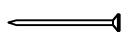

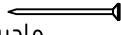

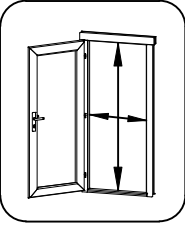
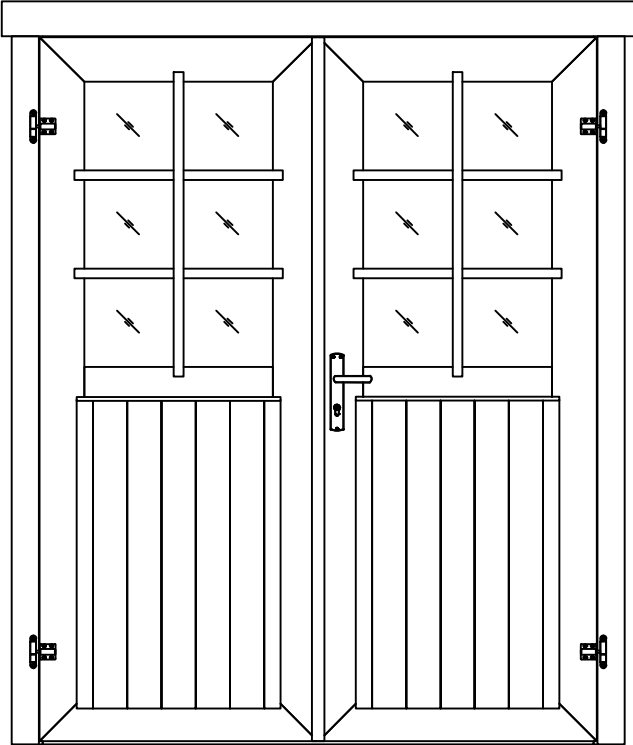
Art.Nr. WC165310

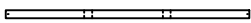
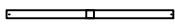

Pos	Piece list - Stückliste - Liste des pièces - Elementi - Stuklijst - Tükitalabel 02.01.2018 Art.Nr. WC165310	5/5	Arv	Profiil (mm)	Pikkus (mm)
001			2	28x57	808
002			32	28x114	808
006			1	28x57	3120
007			48	28x114	3120
008			2	28x120	3120
W1-1			1		
W2-1			1		
A-PR1	Roof beam - Dachbalken - Panne de toit - Perlina del tetto - Gordingen / dakbalk - Põhipärin 		3	44x120	3120
	Roof boards - Dachbretter - Voliges - Perlina per tetto - Dakhout - Katuselaud 		70	90x15	1650
DPL-1	Roofing felt fillet - Dachpappenleiste - Baguette de fixation du feutre bitumeux Asse per fissaggio guaina bituminosa - Afdeklijst asfaltpapier - Katusepapiliist 		4	15x45	1700
	Roofing felt (strip) - Dachpappe (bahnen) - Feutre bitumeux (bande) - Cartone catramato - Asfaltpapier (baan) - Katusepapp 		4		3220
TB-1	Fascia board - Traufbrett - Bandeau de toit - Finitura lati tetto - Gevellijst - Räästalaud 		2	15x45	3120
GL-1	Gable moulding - Giebelleiste - Planche de rive -  Finitura per frontale e retro del tetto - Gevellijst - Viilulaud		4	15x120	1700
HS8	Screw for gable segment - Schrauben für deckblatt - Vis pour fixation losange de finition - Viti x frontali tetto - Schroef voor gevelpunt segment - Kruvi rombile 		4	3.5x35	
HS9	Screw for gable moulding - Schrauben für giebelleiste - Vis pour fixation planche de rive - Vite per fissare finiture davanti e dietro del tetto - Schroef voor gevellijst - Kruvi viilulauale 		24	3.5x50	
HS12	Screw for fascia boards - Schrauben für traufbretter - Vis pour fixation bandeau de toit - Viti x striscia del tetto - Schroef voor gevellijst - Kruvi räästalauale 		14	4x40	
HS18	Screw for roof beams - Schrauben für dachbalken - Vis pour fixation pannes de toit - Viti per perline del tetto - Schroef voor gordingen / dakbalken - Kruvi pärlinefitele 		10	5x120	
SH28	Hammer block - Schlagholz - Calle de frappe - Blocco di legno da usare come cuscinetto quando si usa il martello - Slagklos - Löögiklots 		1		
	Zn nail for roofing felt fillet - Zn nägel für dachpappenleiste - Pointe pour baguette de fixation feutre bitumeux - Chiodi x carta bituminosa x tetto - Spijker(nagel) voor asfaltpapier afdeklijst - Papiliistunael 		20	2x40	
	Roofing nails for roofing felt - Nägel für dachpappe - Pointe pour fixation feutre bitumeux - Chiodi per cartone catramato - Asfaltnagel - Papinael 		132	2.8x15	
GS	Gable segment - Deckblatt - Losange de finition - Decorazione in legno x frontale tetto - Gevelpunt segment - Romb 		2		
	Zn nail for roof - Zn nägel für dachbretter - Pointe pour fixation voliges de toit - Chiodi x perline tetto - Spijker(nagel) voor dakhout - Nael katuselauale 		230	2x50	
	Door - Tür - Porte - Porte - Deur - Uks 14.94x1850 TUK.2.056.SVP.MX28 SGA+28		1		

Pos	18.12.2017	Piece list - Stückliste - Liste des pièces - Elementi - Stuklijst - Tükítabel 1494x1850 TUK.2.056.SVP.MX28 SGA+28	1/2	Q	P (mm)	L (mm)
		Glass size - Glasgröße - Taille de la vitre - Misura del vetro - Glas afmeting - Klaasi mõõt: 502x750 mm				
						 1418x1794 mm
						
1	Upper door jamb - Türrahmen oben - Cadre de porte supérieur - Telaio superiore della porta - Bovendorpel - Ukse ülemine leng		1	66x100	1438	
2	Left door jamb - Türrahmen links - Cadre de porte gauche - Telaio montante sinistro della porta - Linkerstijl deurframe - Ukse vasak leng		1	66x80	1850	
3	Right door jamb - Türrahmen rechts - Cadre de porte droit - Telaio montante destro della porta - Rechterstijl deurframe - Ukse parem leng		1	66x80	1850	
4	Doorstep - Swelle - Barre de seuil - Soglia della porta - Deurdorpel - Lävepakk		1	18x18	1418	
5	Connection strip - Deckleiste - Baguette de battement - Profilo verticale della porta - Stulpilist - kokkuvaltsiliist		1	13x32	1812	
6	Georgian bars - Sprossen - Croisillons - La griglia georgiana - Raamverdeling - Petteliistud		2	15x25	784	
7	Georgian bars - Sprossen - Croisillons - La griglia georgiana - Raamverdeling - Petteliistud		4	15x25	536	



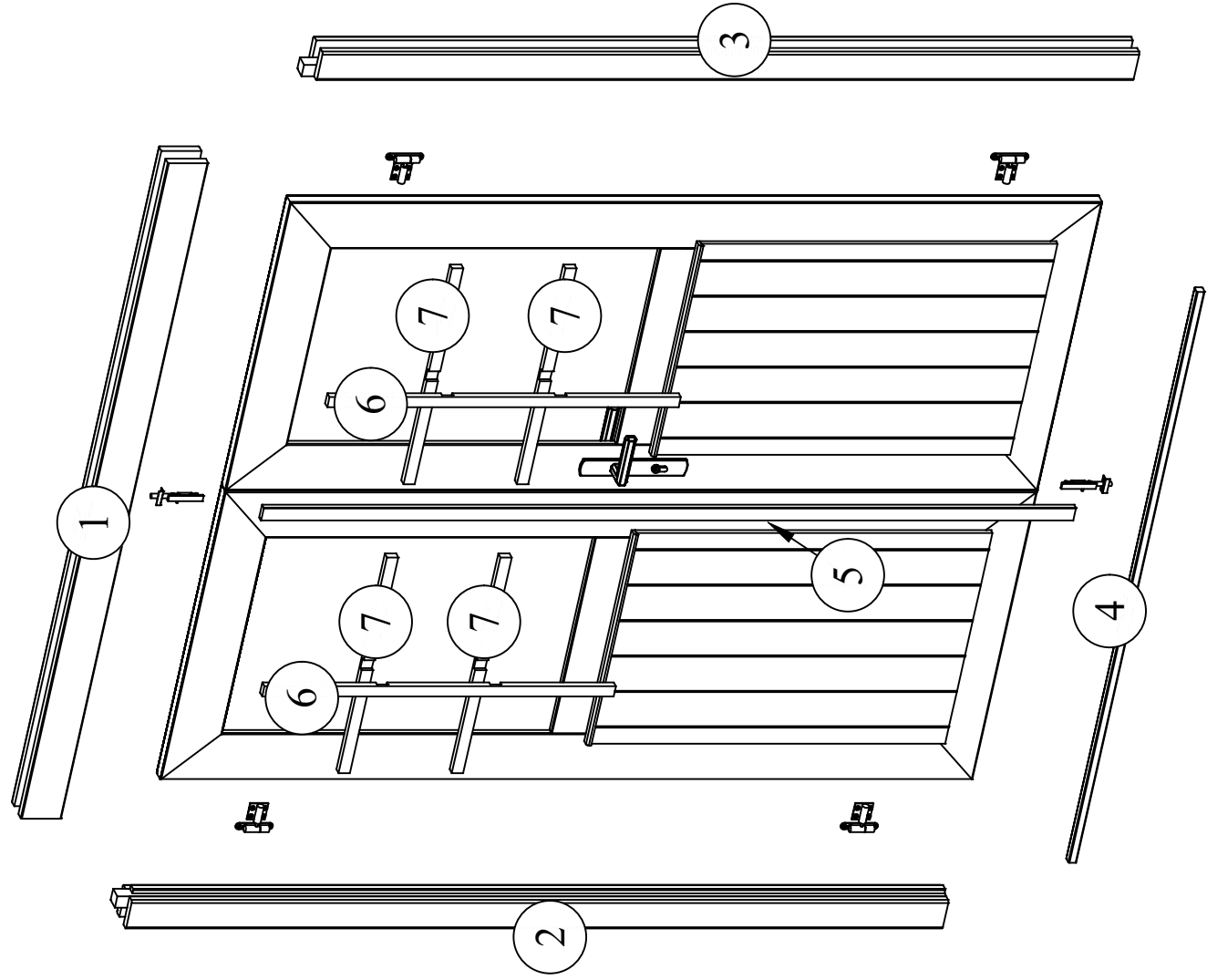



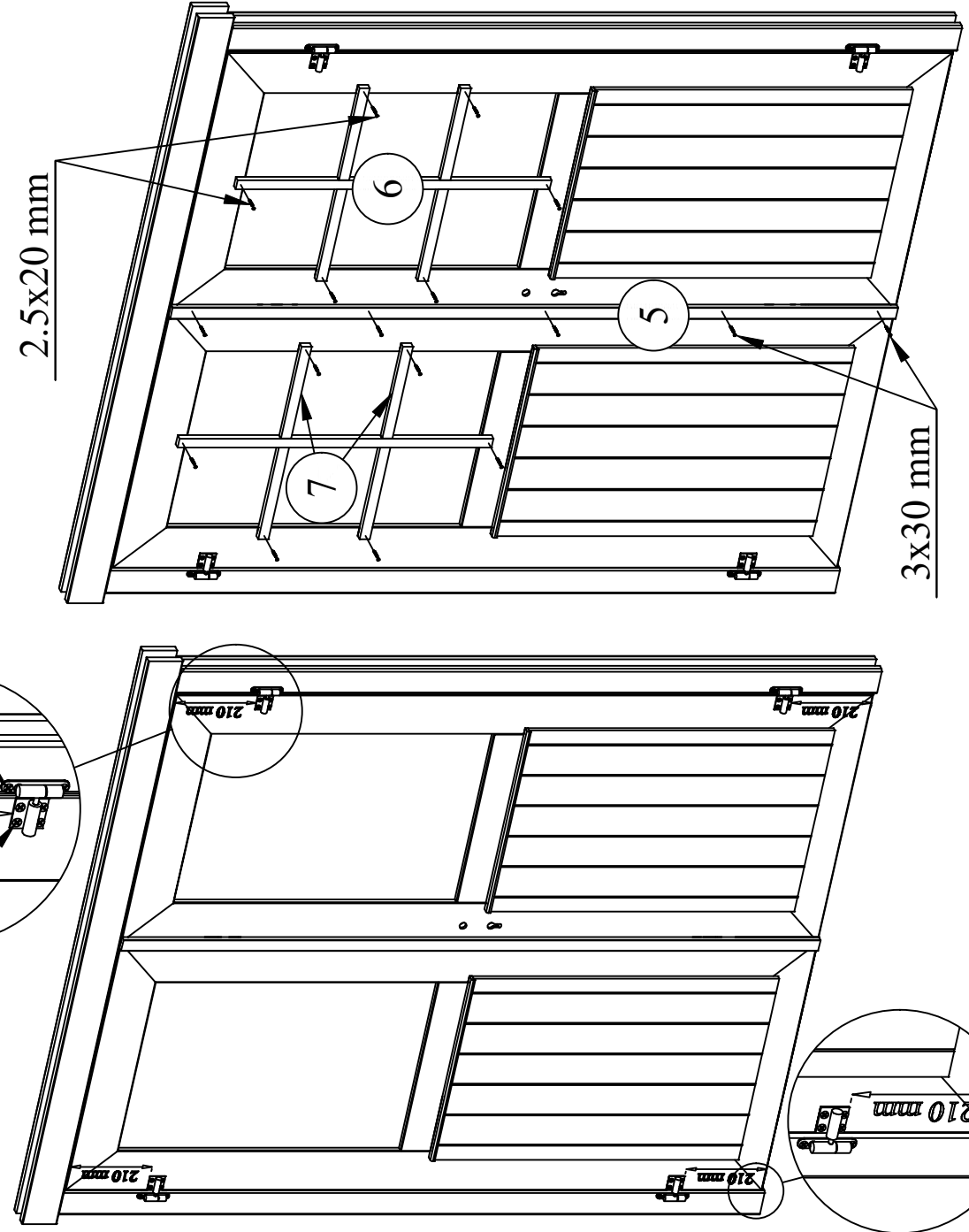
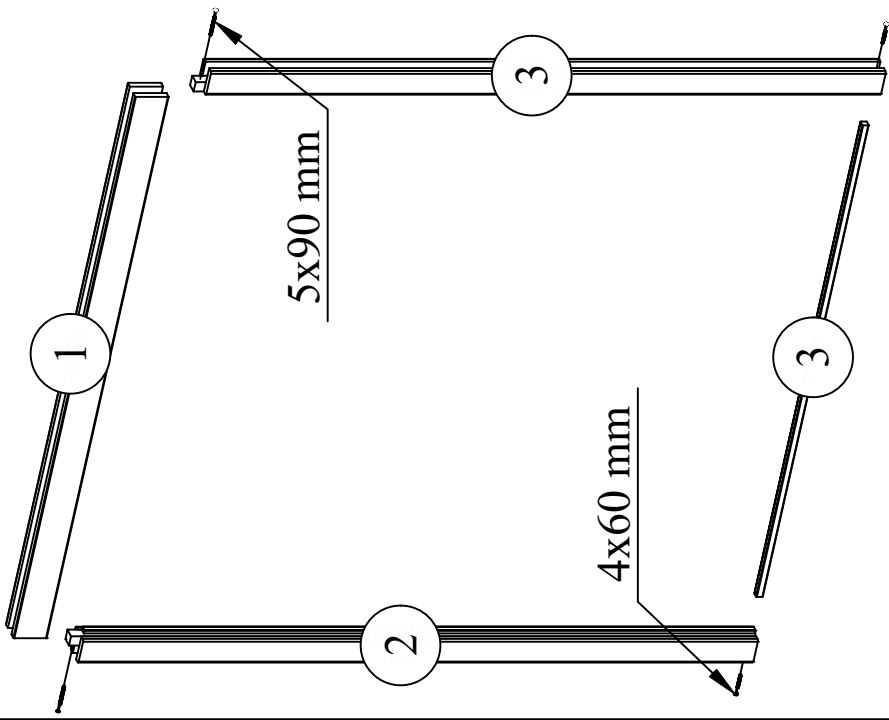

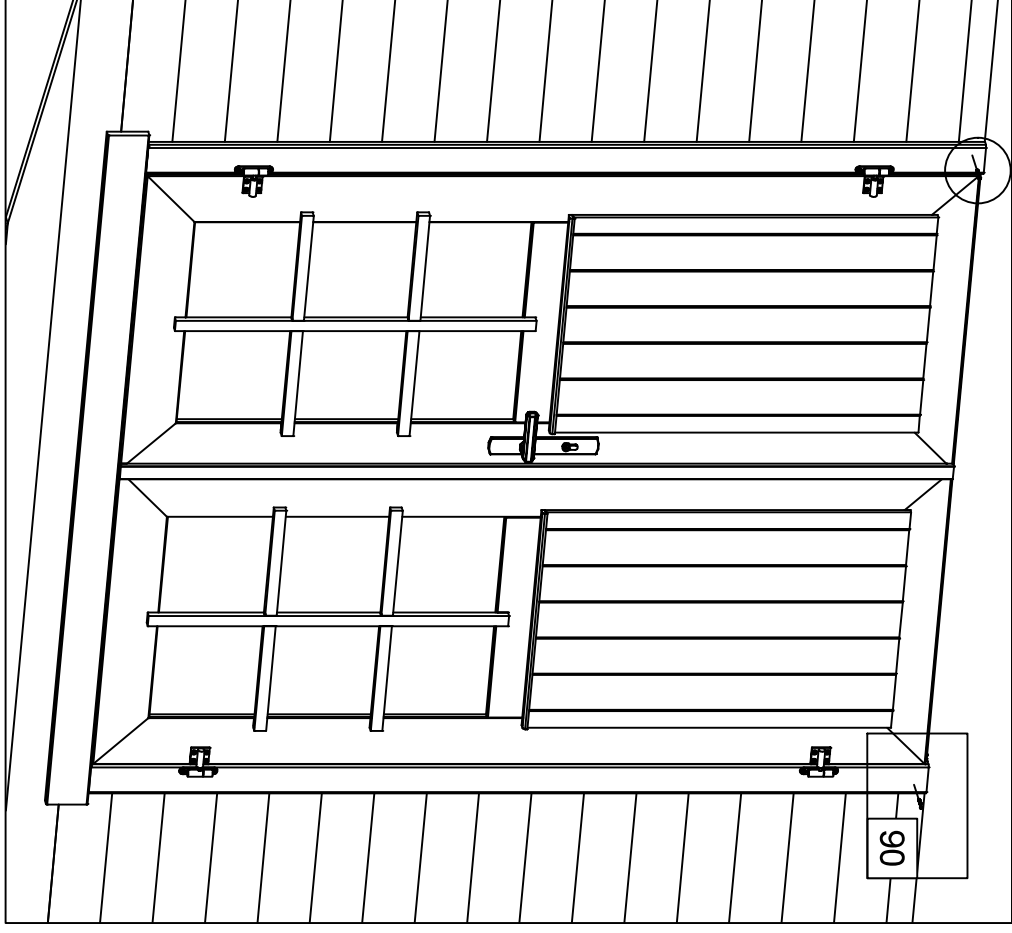
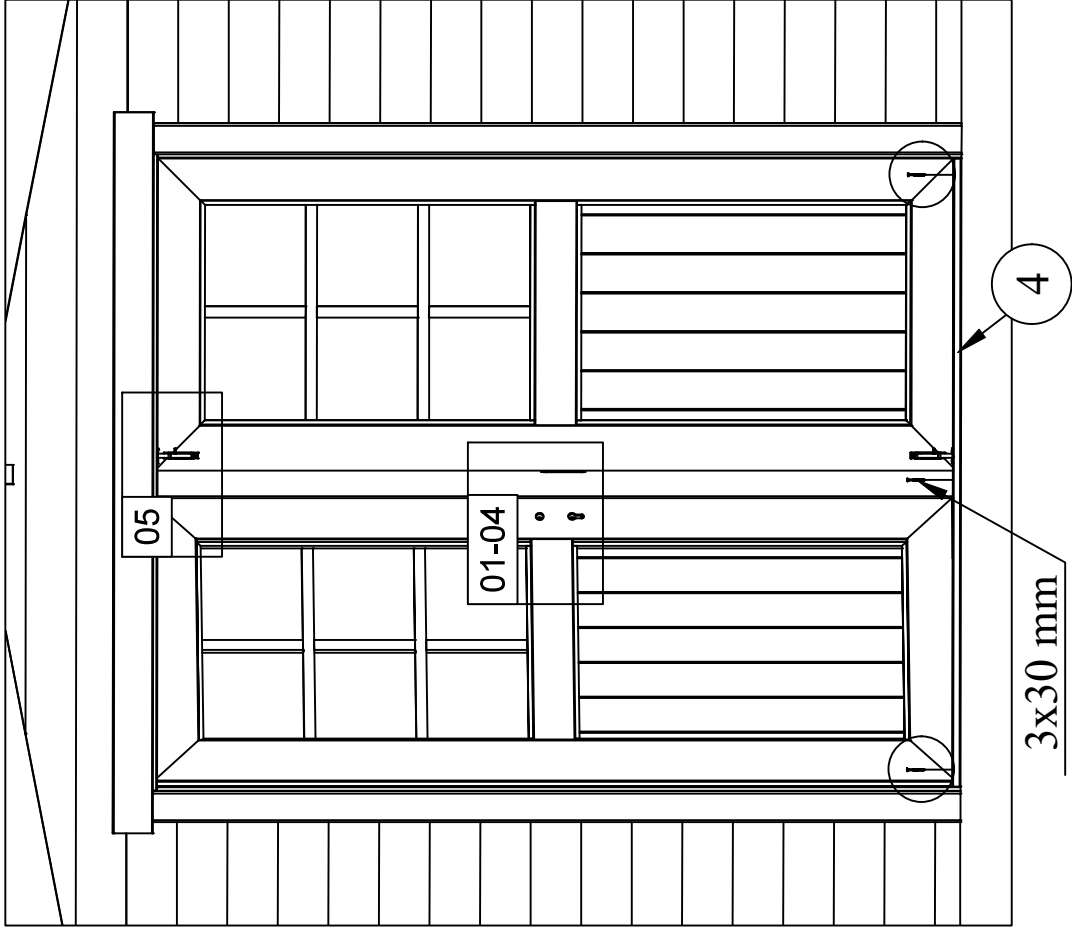

01

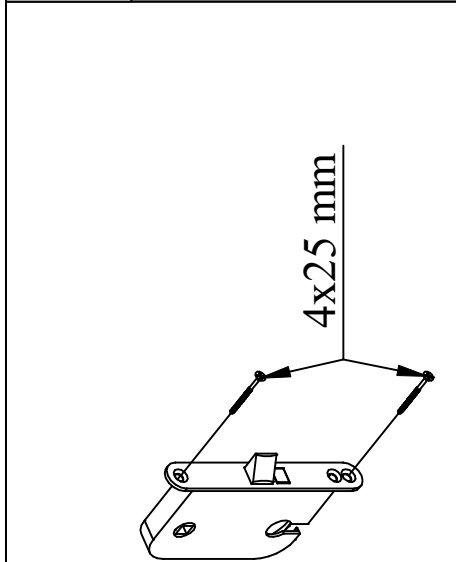

04

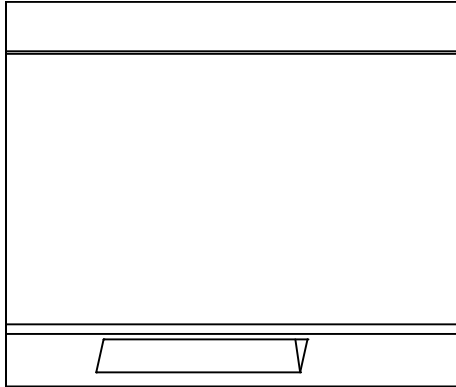
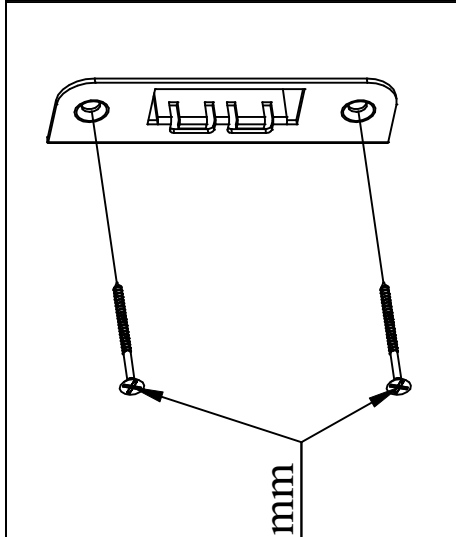

02

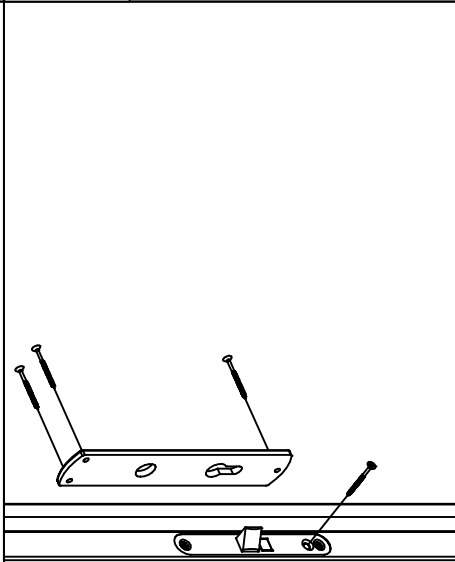
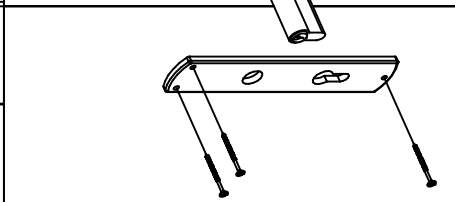

05

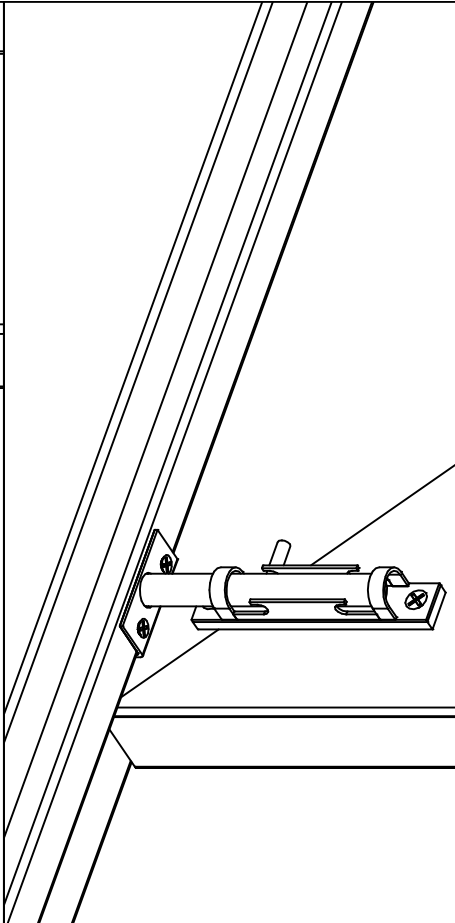

03

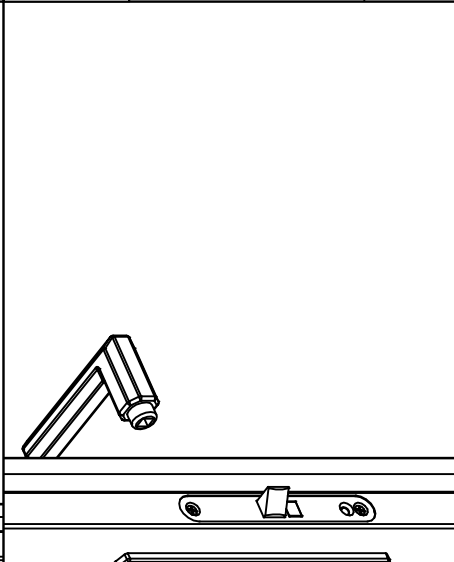
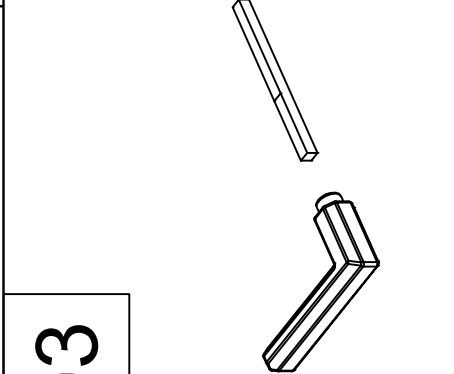

06

