

**DANCOVER<sup>®</sup>**

**.com**

Manual  
for  
Storage Shelter/Arched Tent  
8x15x4,33m

# DANCOVER<sup>®</sup>

.com

## Safety Advice

### Attention

In some countries approval is needed to set up a tent larger than 75 m<sup>2</sup>. It is your responsibility to comply with local rules and regulations and to ensure that the tent is assembled correctly.

In case of bad weather conditions, it is your responsibility to ensure the tent is safely secured and that the tent does not cause damage to others.

Do not use open fire, welding equipment or other sources which can ignite, inside or close to the tent.

The tent must be safely secured. We recommend you secure your tent with straps and pegs as soon as it is assembled.

Make sure to check if the tent is covered by your home contents insurance.

Tents must be evacuated under extreme weather conditions.

In the event of snow, always remove snow from the roof of the tent regularly to prevent snow from building on the roof, as heavy snow can cause the tent to collapse.

In the event of rain, there is a risk of rain puddles building up on top of the roof of the tent. Heavy rain puddles can cause the roof to collapse. It is your responsibility to ensure rain puddles do not build up. As a precaution, make sure the roof of the tent is stretched out properly and adequately over the side frames of the tent and remove rain water regularly.

Do not unpack or repack your tent in freezing temperatures. In case of temperatures below zero, always unpack and repack your tent indoors to avoid the risk of cracking parts.

The tent must be totally dry before you repack and store it to avoid mildew.

**Note:** Dancover warranty applies only to the normal use of the Product, normal wear and tear excepted, in accordance with written use instructions or manual. The warranty does not apply to damage caused by accident, abuse, misuse, or modification of the Product.

## Warranty Information

Please visit [dancovershop.com](http://dancovershop.com) for information on warranty.



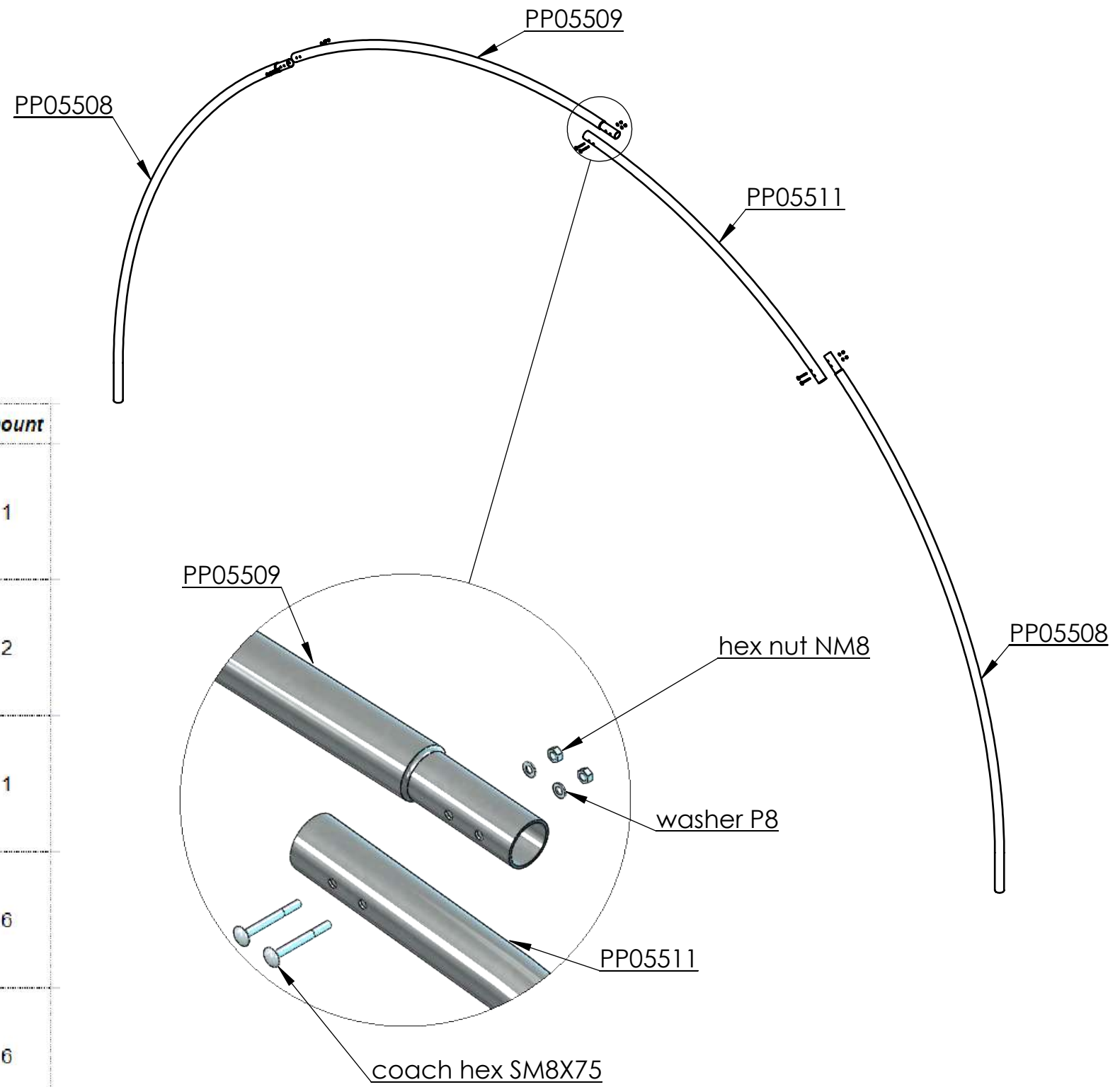
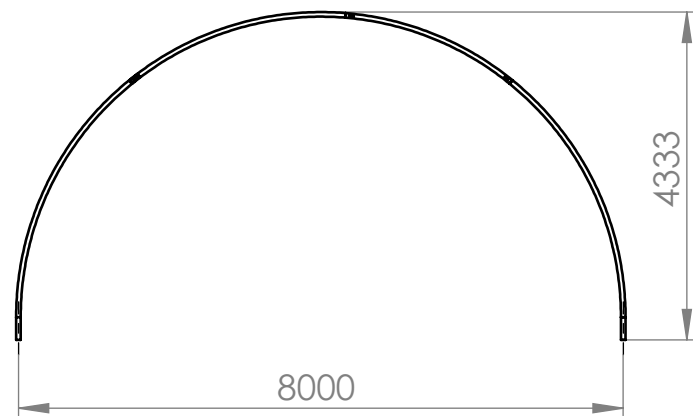



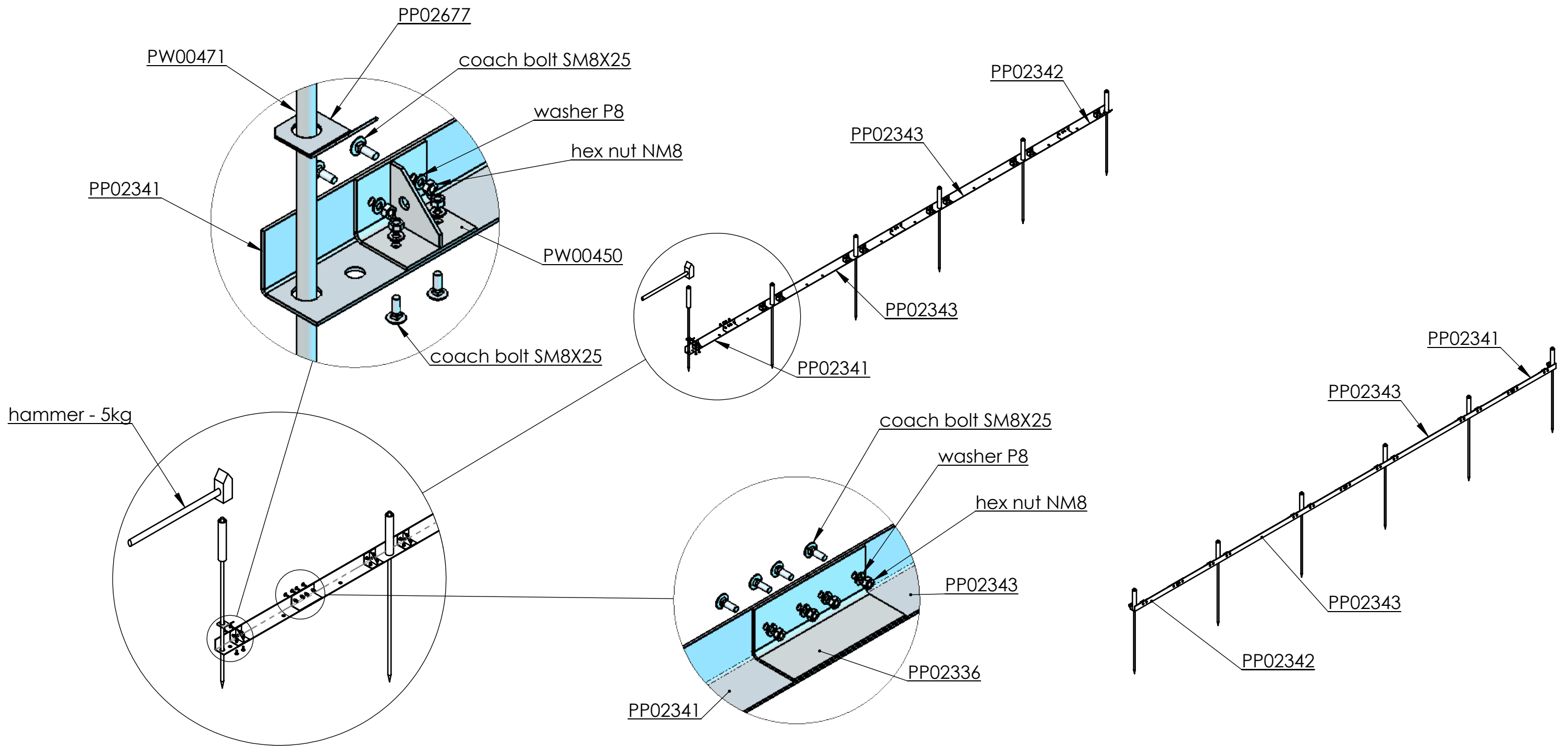
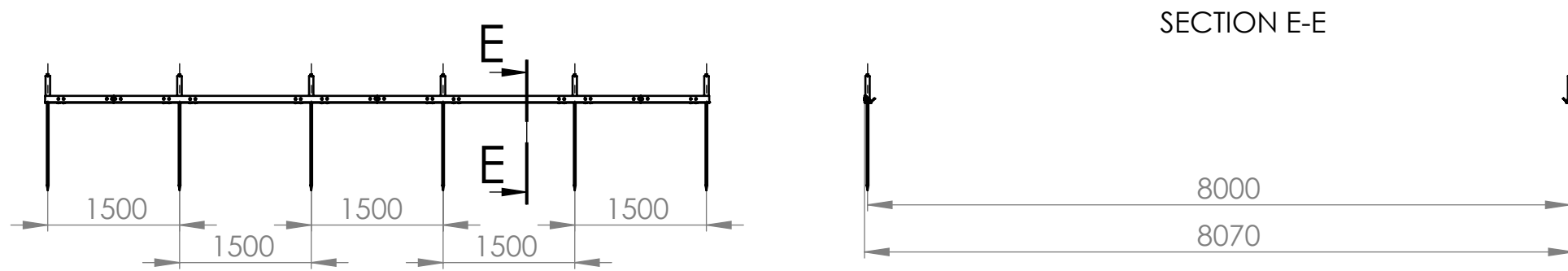

*Please always check our website for the latest safety advice and manual.*



No.	Number	Description	Element View	Weight [kg]	Amount
1	PP05511	Circular Hollow Section 60.3x3 / L=2390mm		10,1	1
2	PP05508	Circular Hollow Section 60.3x3 / L=4000mm		16,8	2
3	PP05509	Circular Hollow Section 60.3x3 / L=3185mm		13,3	1
4		SM8X75 DIN603-8.8OC			6
5		P8-DIN125A-OC			6
6		NM8-DIN934-8.8OC			6

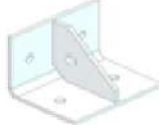





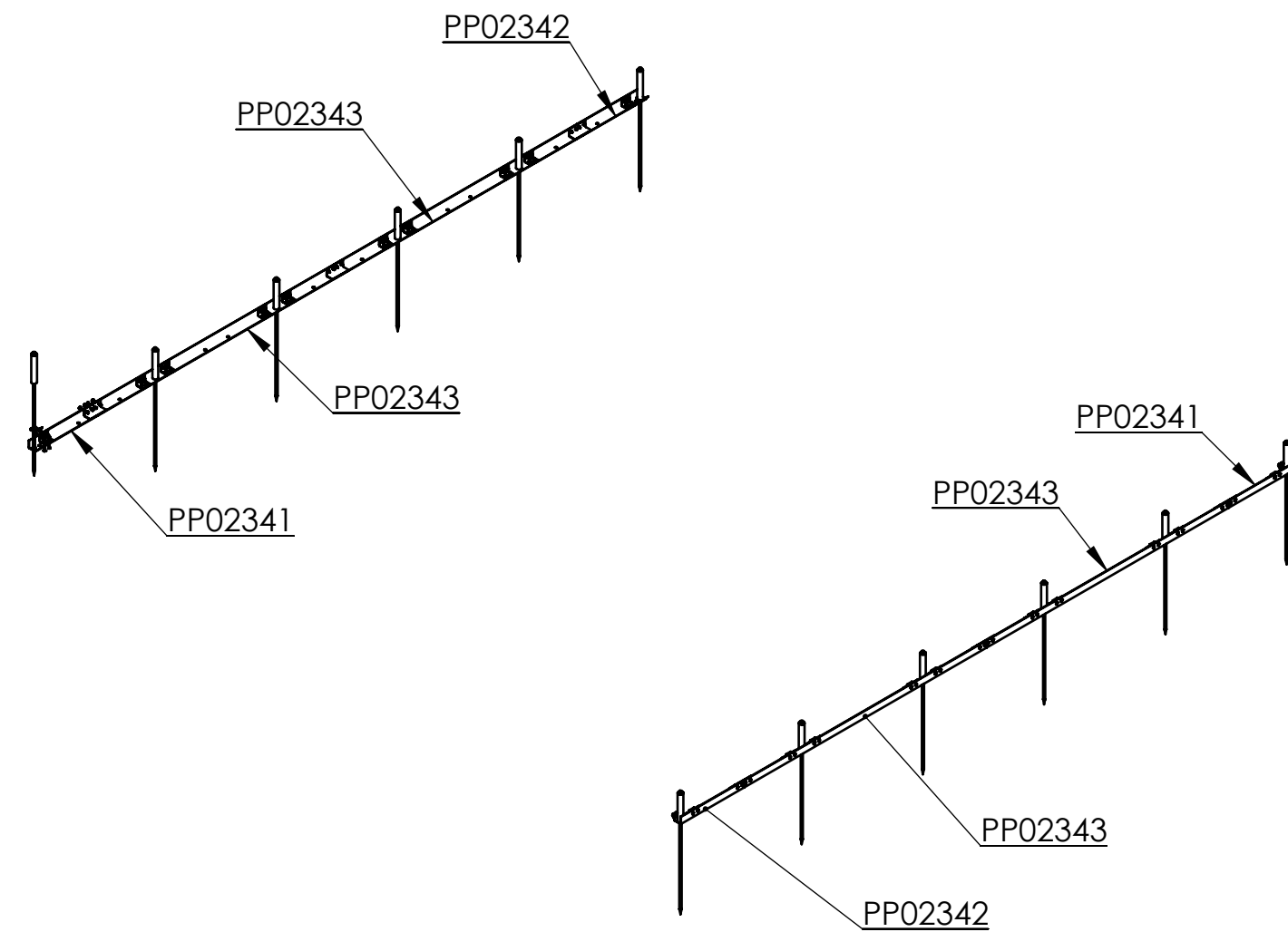



*mounting instruction - substructure*

No.	Number	Description	Element View	Weight [kg]
1	PW00471	Tent Pin L=1320mm		8,0
2	PP02341	Steel Angle 80x80x4 / L=780mm		3,7
3	PP02342	Steel Angle 80x80x4 / L=780mm		3,7
4	PP02343	Steel Angle 80x80x4 / L=3000mm		14,3
5	PP02349	Steel Angle 80x80x4 / L=1500mm		7,1
8	PW00450	Steel Angle with Rib		0,5
7	PP02338	Steel Angle 76x76x4 / L=200mm		0,9
25		SM8X25 DIN603-8.8OC		
29		F8-DIN125A-OC		
30		NM8-DIN934-8.8OC		







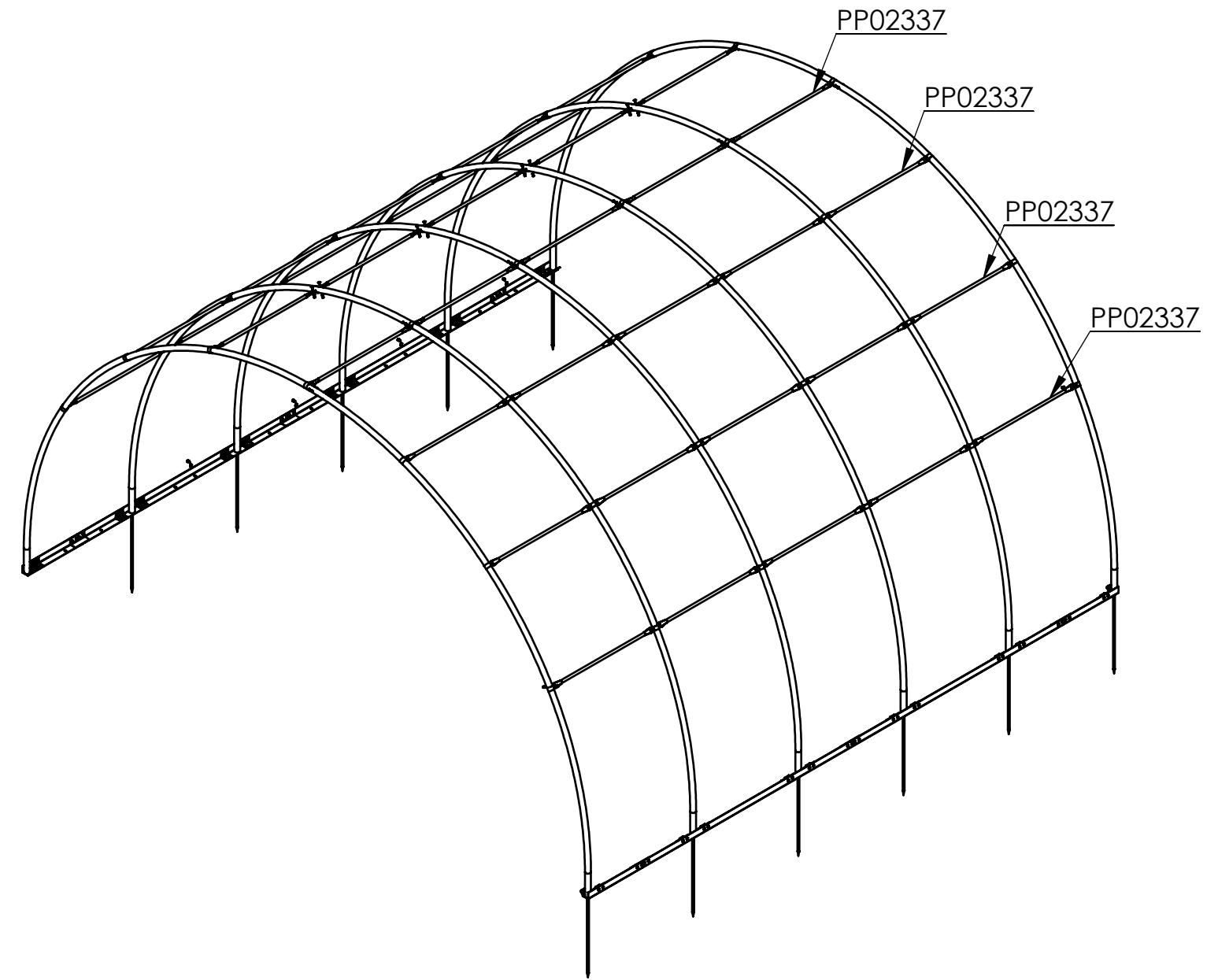



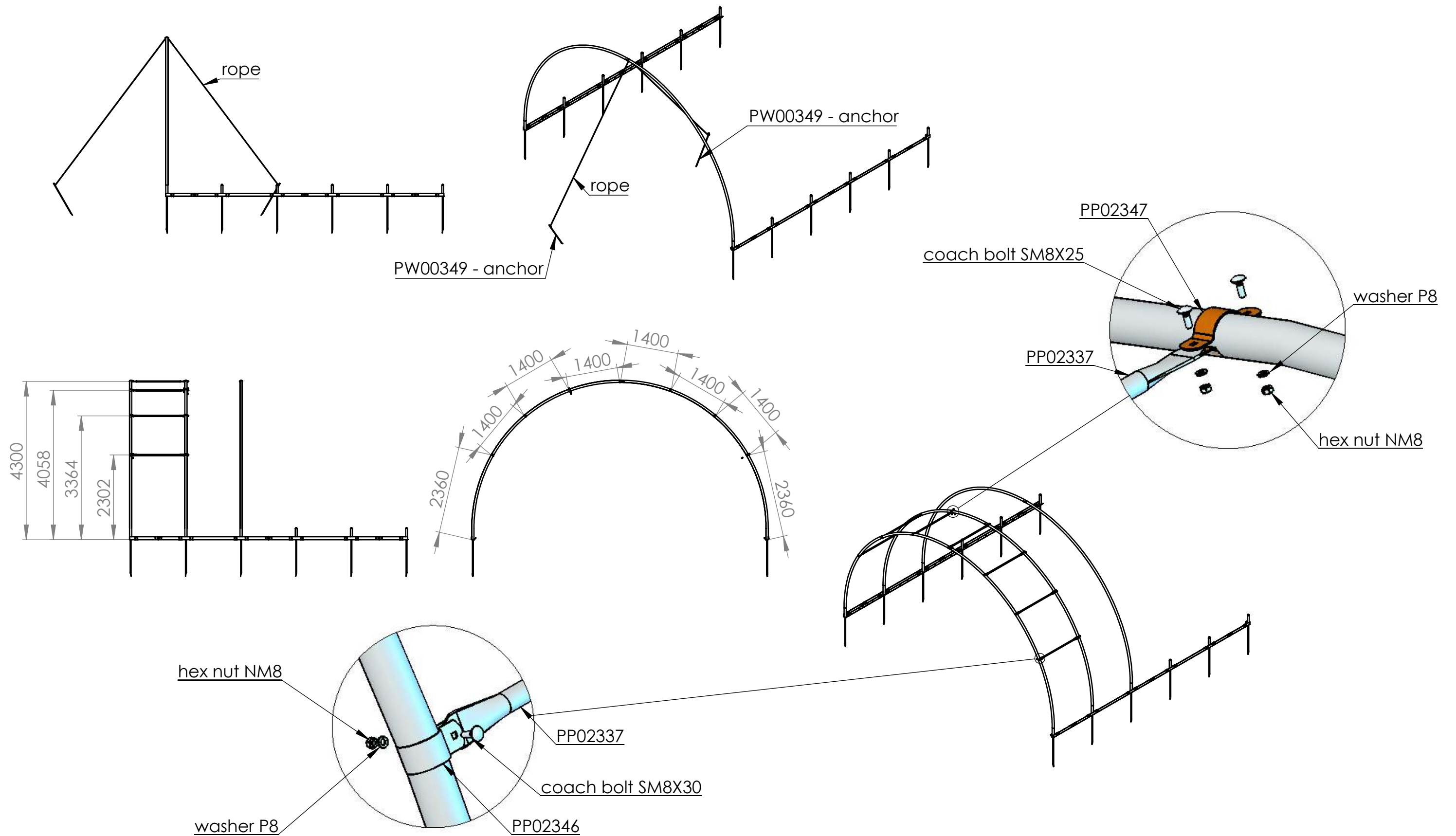

No.	Number	Description	Element View	Weight [kg]
1	PW00349	Tent Pin		1,6
2	PP02337	Circular Hollow Section 30x1.5 / L=1420mm		1,9
3	PP02346	Pipe Clamp $\Phi 40$		0,2
4	PP02347	Pipe Clamp $\Phi 60$		0,1
5		SM8X25 DIN603-8.8OC		
6		SM8X30 DIN603-8.8OC		
7		P8-DIN125A-OC		
8		NM8-DIN934-8.8OC		



*mounting instruction - mounting of struts for section*



*mounting instruction - mounting of struts for section*

No.	Number	Description	Element View	Weight [kg]	Amount
1	PP02334	Circular Hollow Section 40.0x1.5 / L=1600mm		2,6	8
2	PP02335	Circular Hollow Section 35.0x1.5 / L=1600mm		2,2	8
3	PP02346	Pipe Clamp $\Phi 40$		0,2	4
4		SM8X25 DIN603-8.8OC			8
5		SM8X30 DIN603-8.8OC			16
6		P8-DIN125A-OC			24
7		NM8-DIN934-8.8OC			24

struts

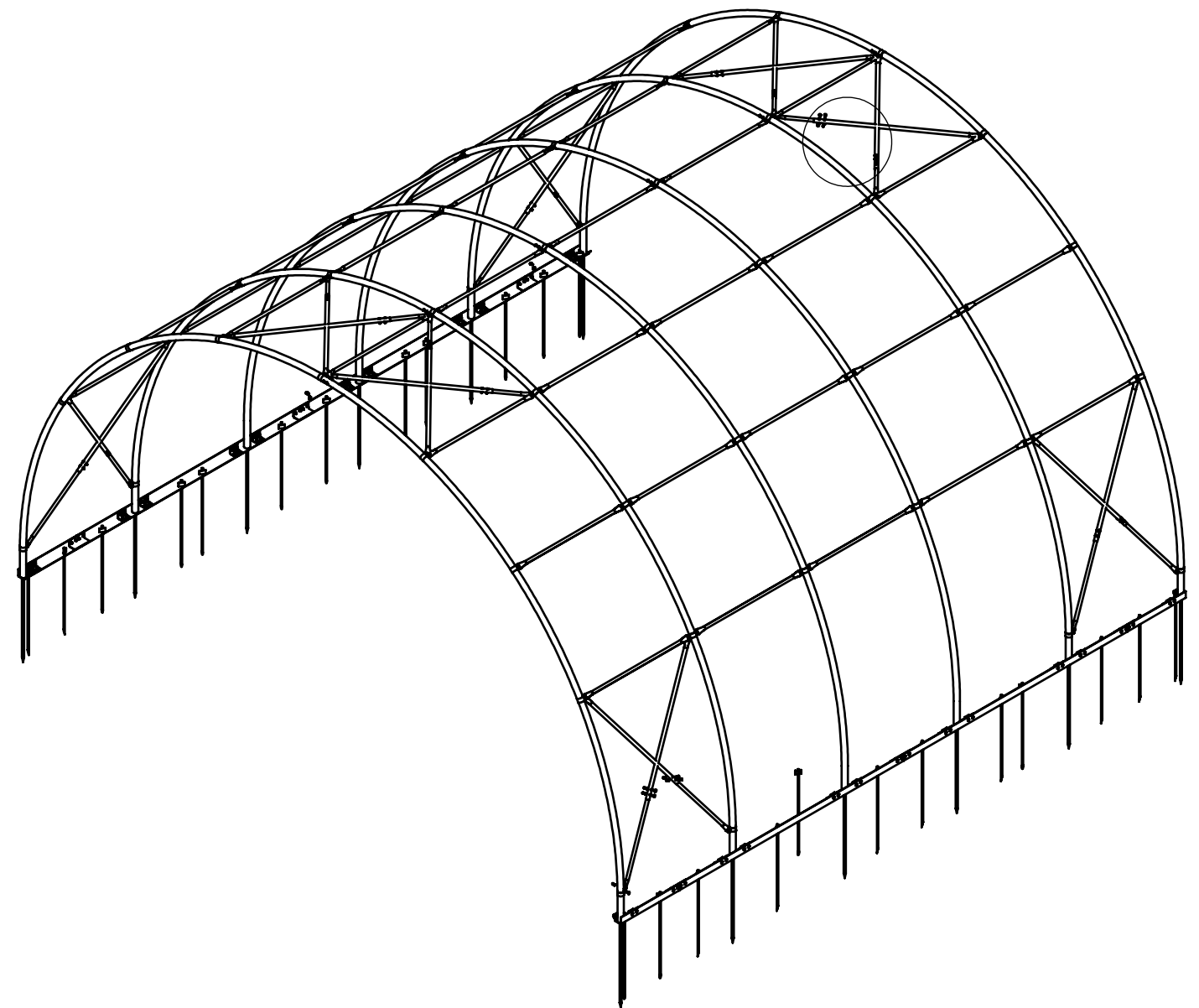



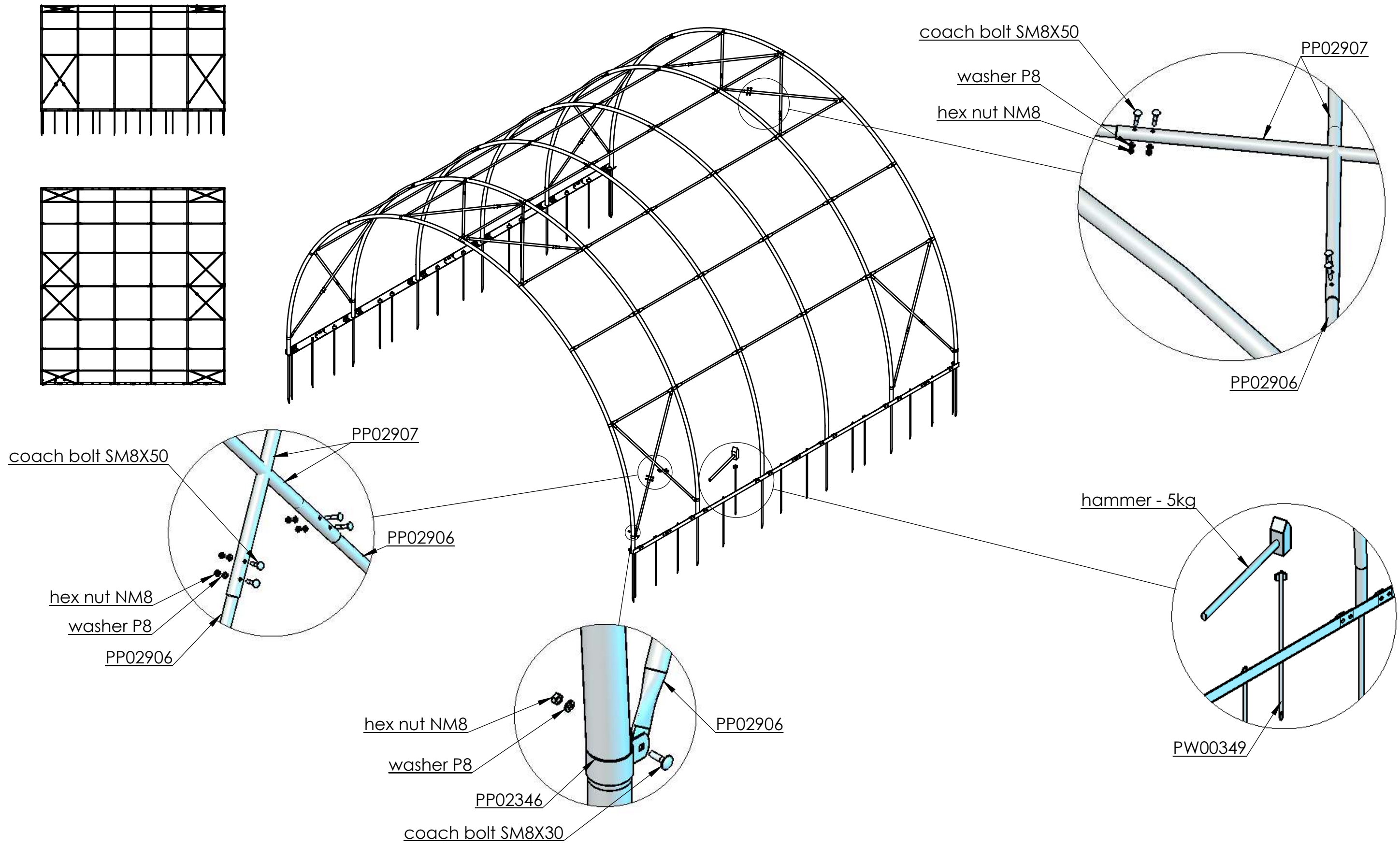

note:  
extra struts used in first section  
and in the hall from 15m length

*mounting instruction - mounting extra struts*







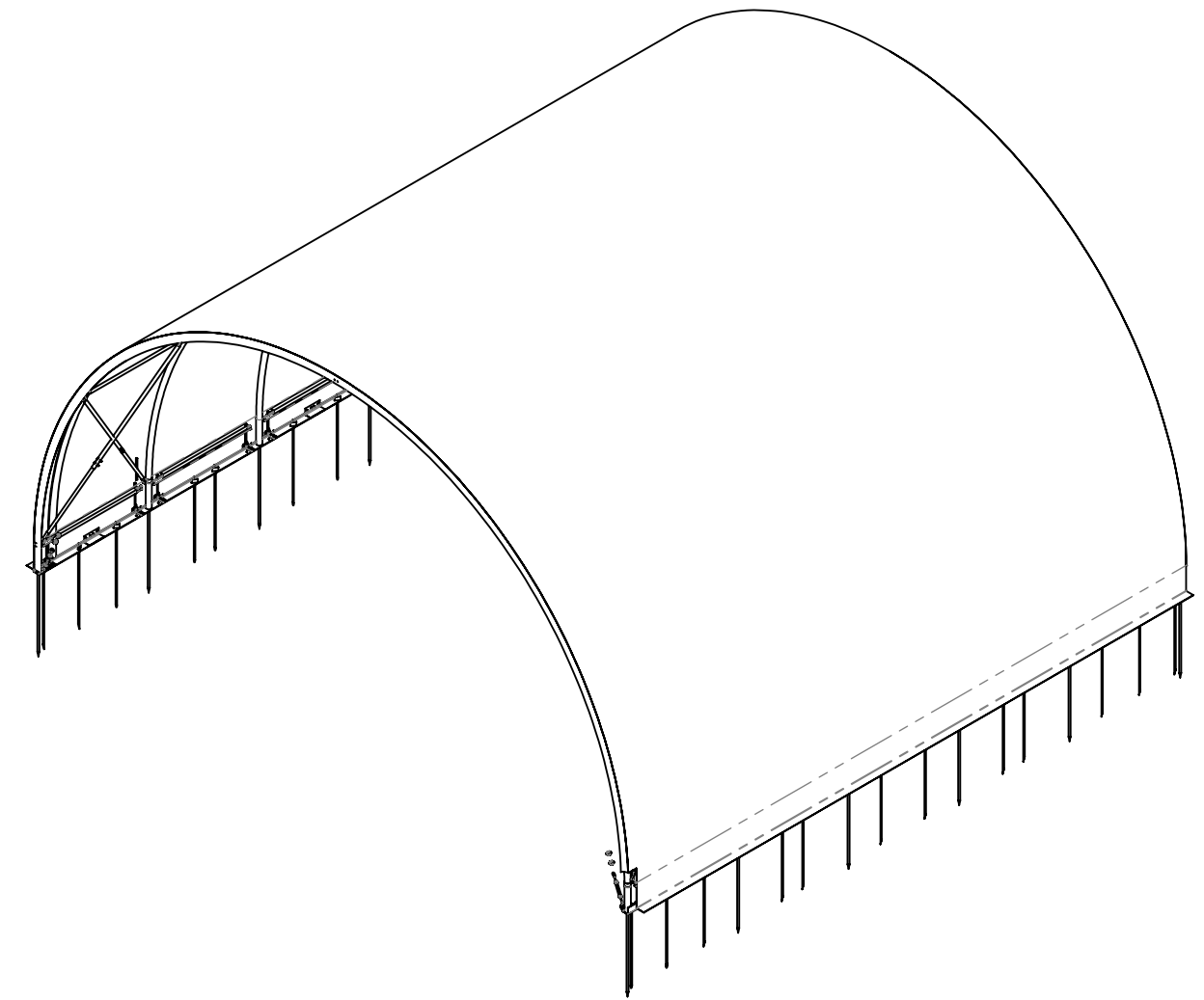

*mounting instruction - mounting extra strut*

No.	Number	Description	Element View	Weight [kg]	Amount
1	PP02333	Rectangular Hollow Section 40x20x2 / L=1300mm		2,2	2
2	PW01650	Hook for Mount the Taurpaulin		0,3	4
3		P10-DIN125A-OC			4
4		NM10-DIN934-8.8OC			4
5		Profile End Cap			4

PER SECTION



No.	Number	Description	Element View	Weight [kg]	Amount
1	KK01122	Tightening screw M10		0,3	4
2	KK01259	Wire Rope Clamp			8
3		Thimble stainless			4
4		Roof Tarpaulin			1

*mounting instruction - components for tension canvas*

rope for pull of canvas

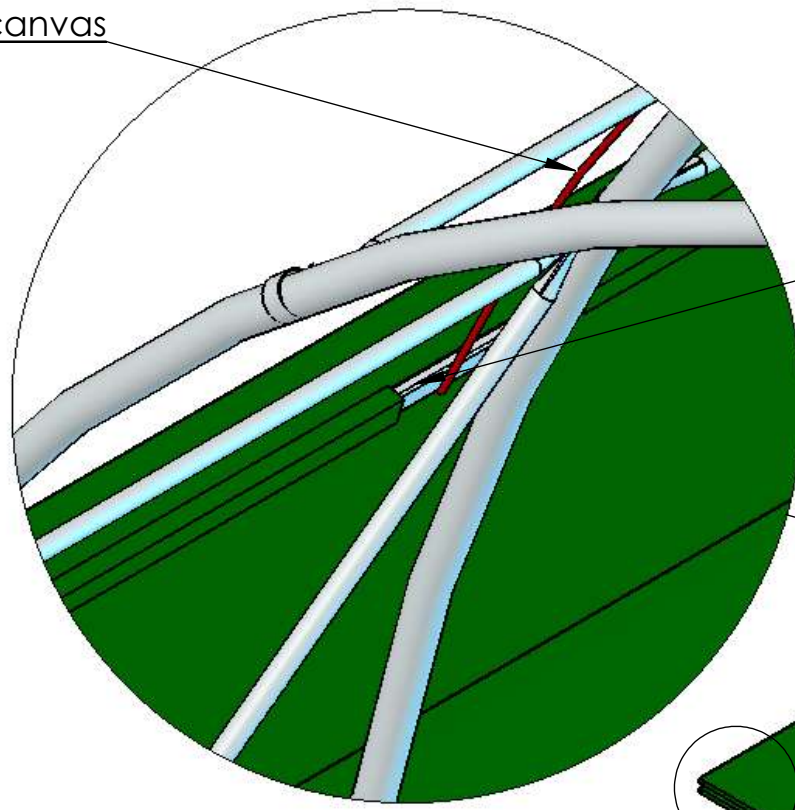

PP02333

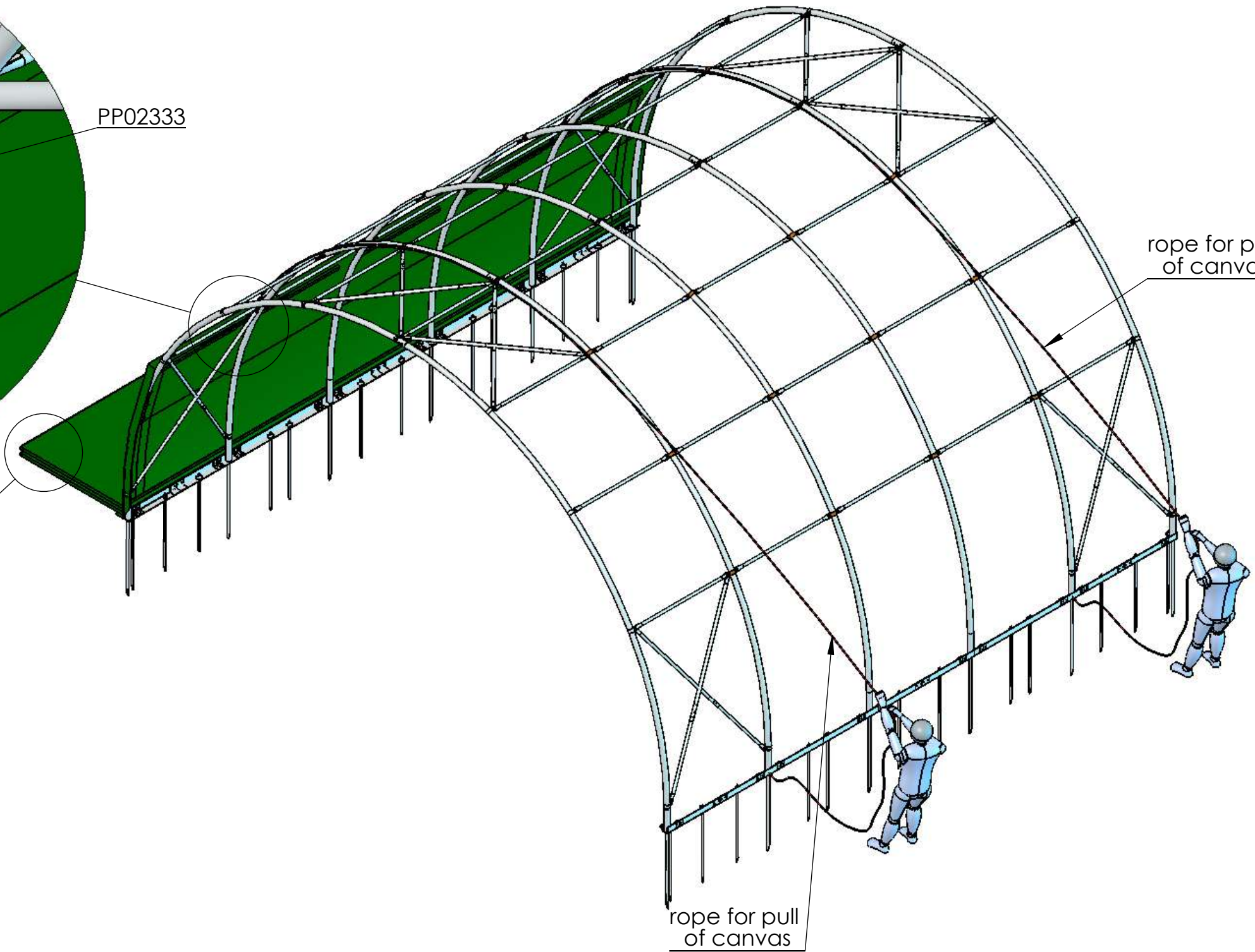

rope for pull of canvas

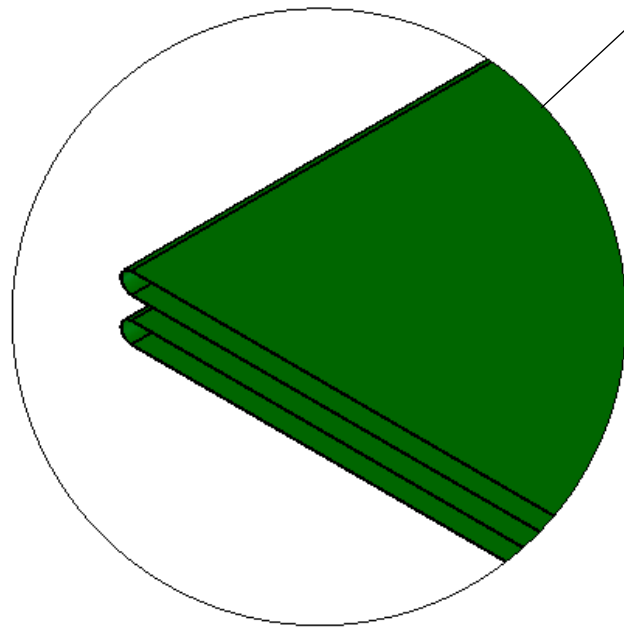

rope for pull of canvas

*mounting instruction - components for tension canvas*



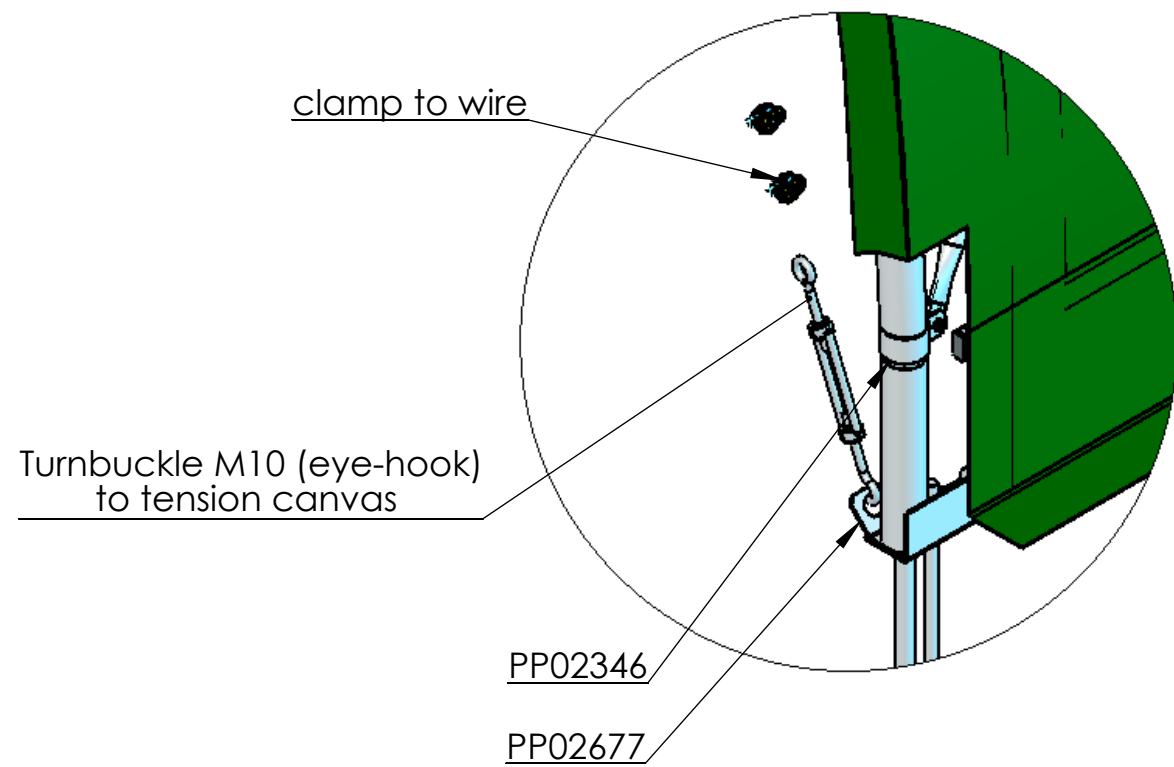
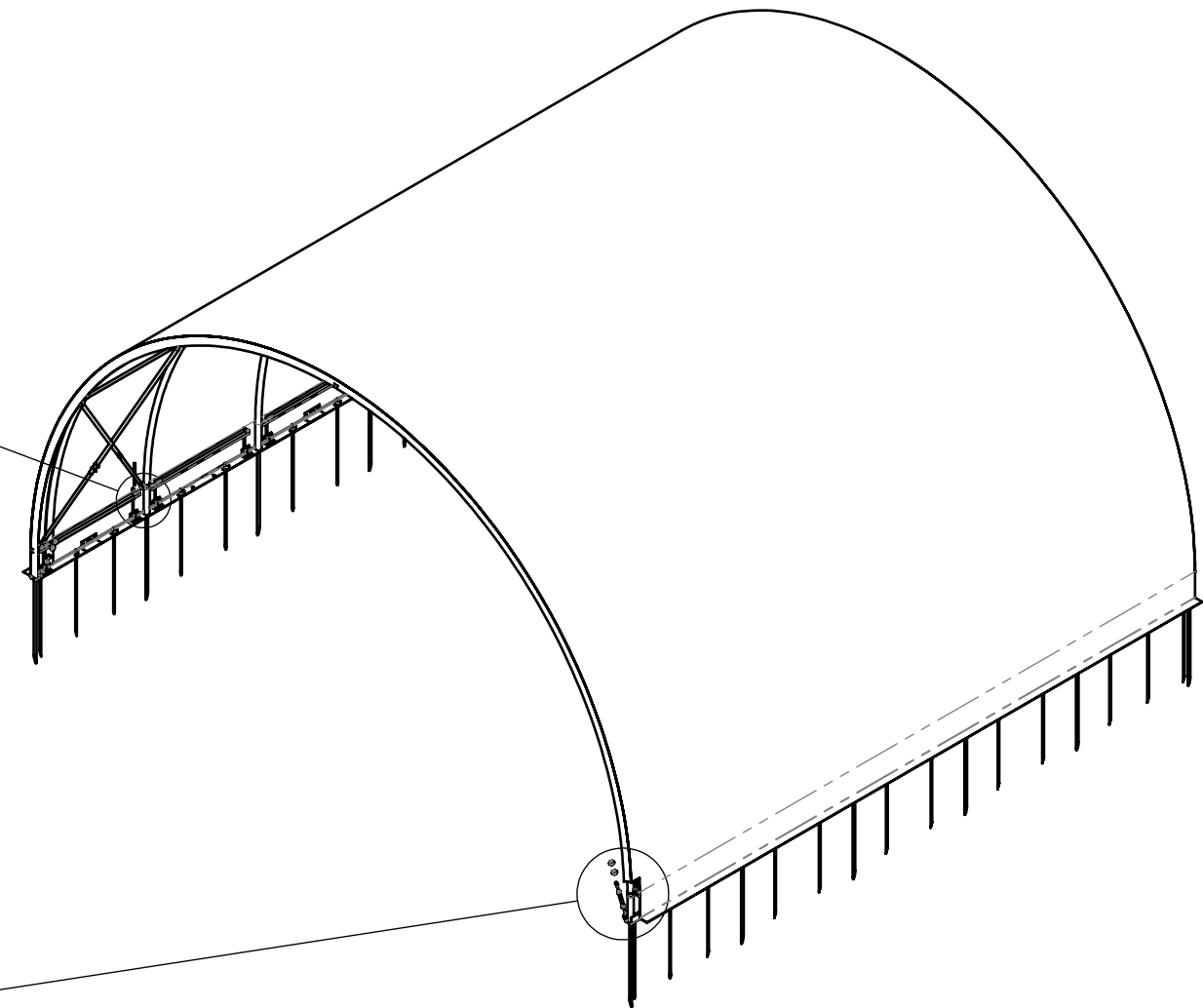
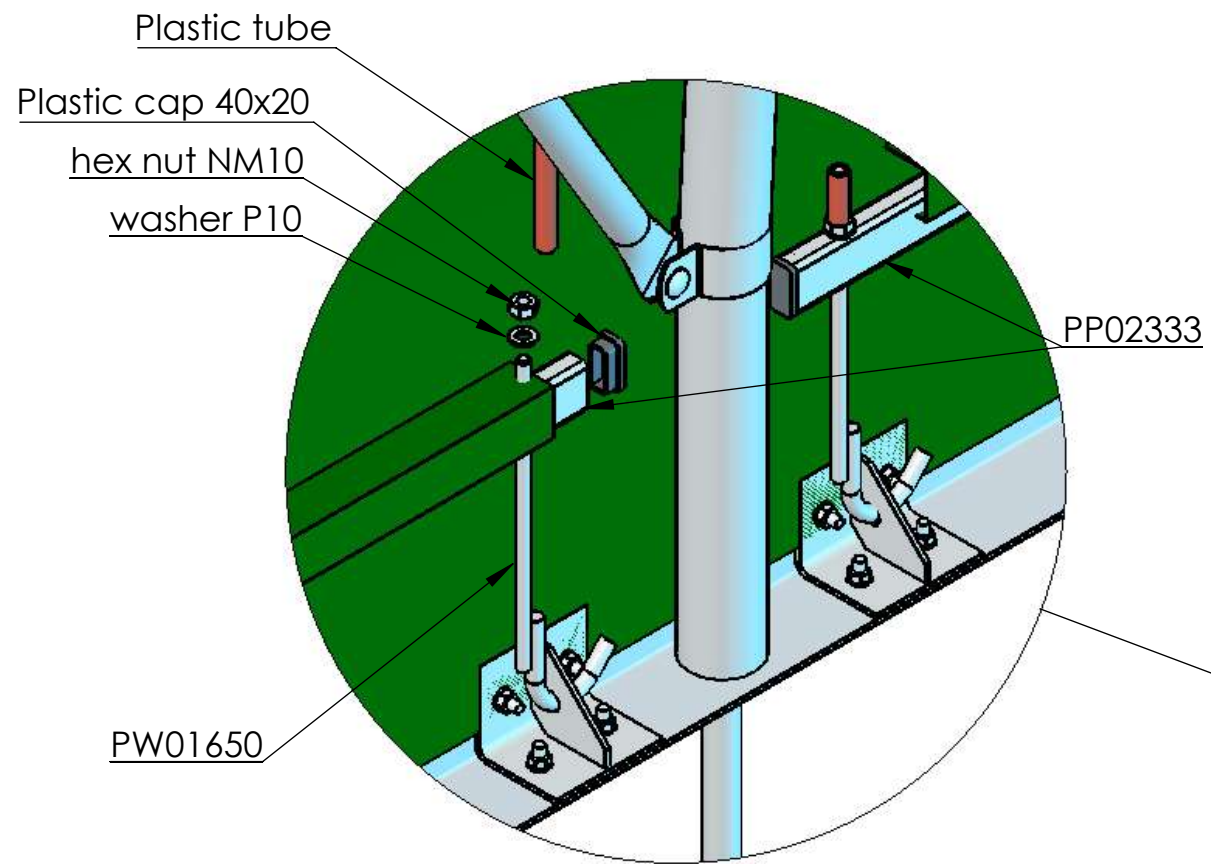

*mounting instruction - tension canvas*

# DANCOVER<sup>®</sup>

.com

## Contact information

### Head office:

Dancover A/S  
Nordre Strandvej 119 G  
3150 Hellebæk  
Denmark

For more information  
please visit:  
[www.dancovershop.com](http://www.dancovershop.com)

## National contact

Denmark: 70 26 76 20  
[denmark@dancover.com](mailto:denmark@dancover.com)

UK: 020 8099 7570  
[uk@dancover.com](mailto:uk@dancover.com)

Germany: 041 0266 7040  
[germany@dancover.com](mailto:germany@dancover.com)

France: 0975 181 800  
[france@dancover.com](mailto:france@dancover.com)

Sweden: 040 233 262  
[sverige@dancover.com](mailto:sverige@dancover.com)

Finland: 0 931 581 720  
[suomi@dancover.com](mailto:suomi@dancover.com)

Poland: 22 300 8602  
[polska@dancover.com](mailto:polska@dancover.com)

Luxembourg: +49 041 0266 7040  
[luxembourg@dancover.com](mailto:luxembourg@dancover.com)

Portugal: 308 800 899  
[portugal@dancover.com](mailto:portugal@dancover.com)

Spain: 911 436 828  
[espana@dancover.com](mailto:espana@dancover.com)

Italy: 02 479 21 198  
[italia@dancover.com](mailto:italia@dancover.com)

Switzerland: 0840 000125  
[schweiz@dancover.com](mailto:schweiz@dancover.com)

Austria: 0662 626935  
[austria@dancover.com](mailto:austria@dancover.com)

Norway: 231 00 690  
[norge@dancover.com](mailto:norge@dancover.com)

Nederland: 0 858 880 524  
[nederland@dancover.com](mailto:nederland@dancover.com)

Ireland: 0 151 33 003  
[ireland@dancover.com](mailto:ireland@dancover.com)

Belgium: 0 28 08 08 09  
[belgique@dancover.com](mailto:belgique@dancover.com)