

DANCOVER[®]



Manual
for
Marquee Partyzone
5x5m PVC

DANCOVER[®]

.com

Safety Advice

Attention

In some countries approval is needed to set up a marquee/tent larger than 75 m². It is your responsibility to comply with local rules and regulations and to ensure that the marquee/tent is assembled correctly.

In case of bad weather conditions, it is your responsibility to ensure the marquee/tent is safely secured and that the marquee/tent does not cause damage to others.

Do not use open fire, welding equipment or other sources which can ignite, inside or close to the tent.

The marquee/tent must be safely secured. We recommend you secure your marquee/tent with straps and pegs as soon as it is assembled.

Make sure to check if the marquee/tent is covered by your home contents insurance.

Marquees/tents must be evacuated under extreme weather conditions.

In the event of snow, always remove snow from the roof of the marquee/tent regularly to prevent snow from building on the roof, as heavy snow can cause the marquee/tent to collapse.

In the event of rain, there is a risk of rain puddles building up on top of the roof of the marquee/tent. Heavy rain puddles can cause the roof to collapse. It is your responsibility to ensure rain puddles do not build up. As a precaution, make sure the roof of the marquee/tent is stretched out properly and adequately over the side frames of the marquee/tent and remove rain water regularly.

Do not unpack or repack your marquee/tent in freezing temperatures. In case of temperatures below zero, always unpack and repack your marquee/tent indoors to avoid the risk of cracking parts.









The marquee/tent must be totally dry before you repack and store it to avoid mildew.

Note: Marquees are intended for events and other arrangements and are as such only meant for short term temporary assembly and the following disassembly. Dancover warranty applies only to the normal use of the Product, normal wear and tear excepted, in accordance with written use instructions or manual. The warranty does not apply to damage caused by accident, abuse, misuse, or modification of the Product.

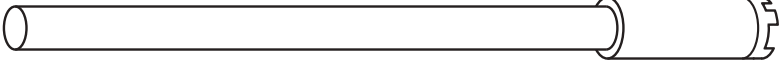
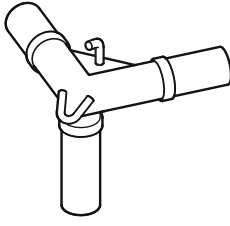
Warranty Information

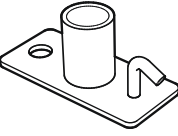
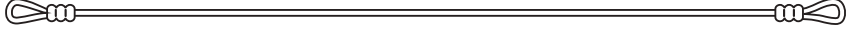
Please visit dancovershop.com for information on warranty.

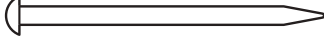
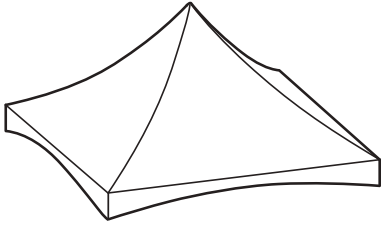
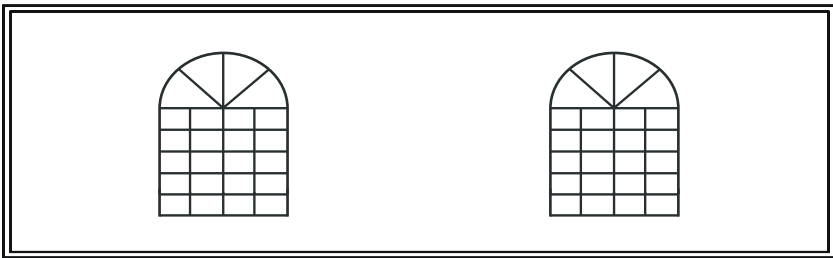
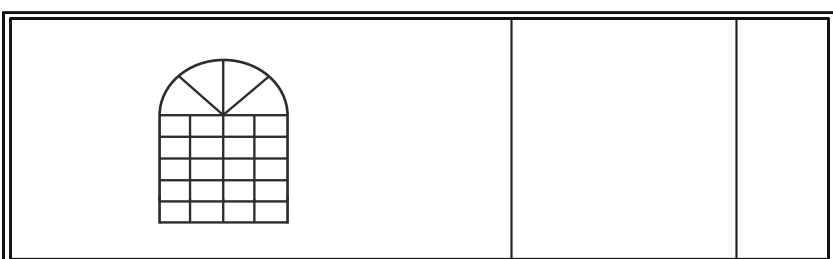
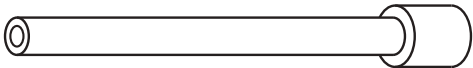
Please always check our website for the latest safety advice and manual.

Part No.	Description	Picture	Quantity
1	Eave Pole		8
2	Leg Pole		4
3	Center Pole		1
4 / A	Corner Joint		4
5 / B	Sleeve		4
6 / C	Foot pad		4
7	Cross Cable		2
8	Ratchet Rope		4
9	Peg		8
11	Roof		1
12	Sidewall		3
13	Sidewall with zipper		1
14	Flag Pole		1
15	Ratchet Stape		4

Frame sketch

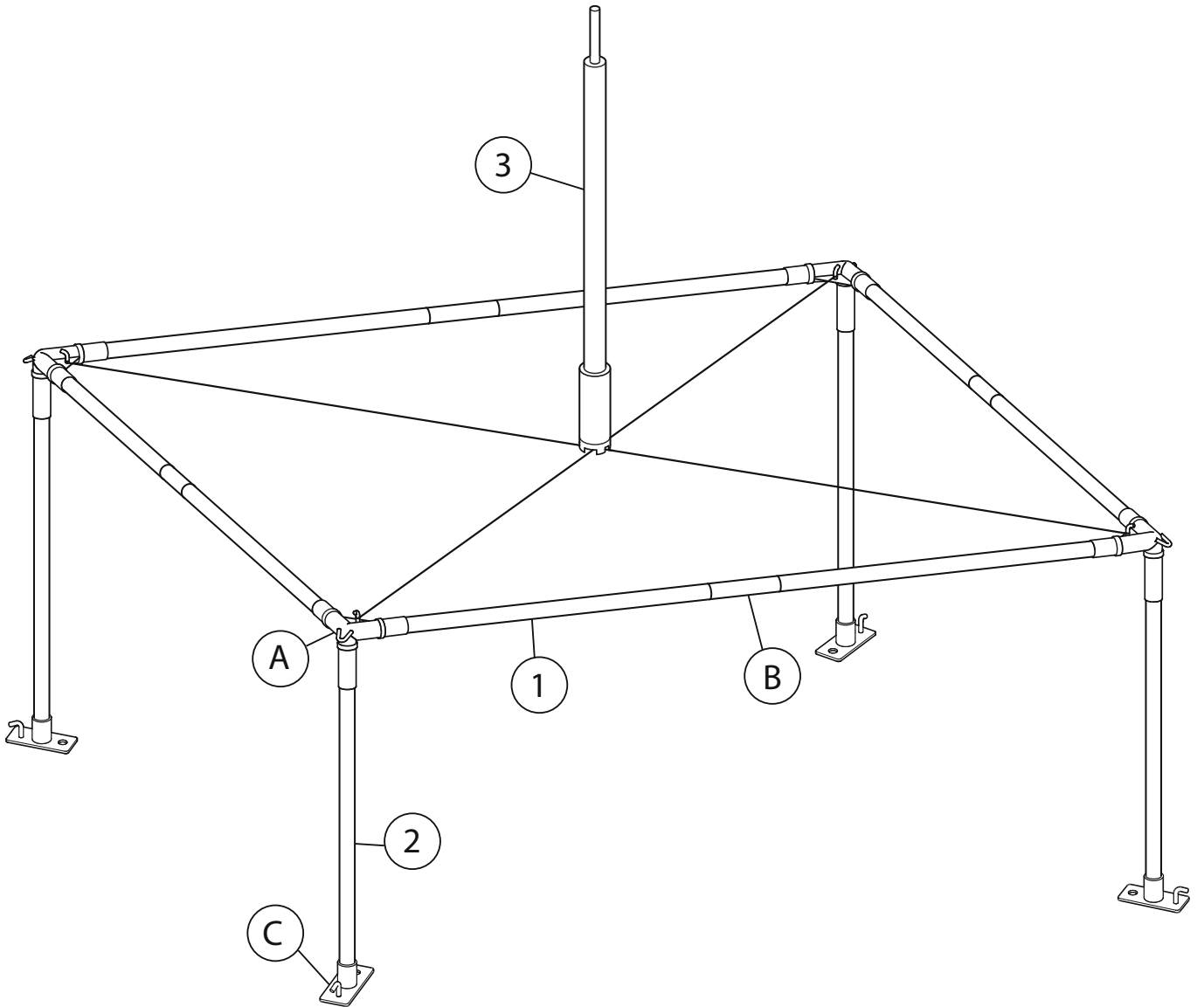

Assembly

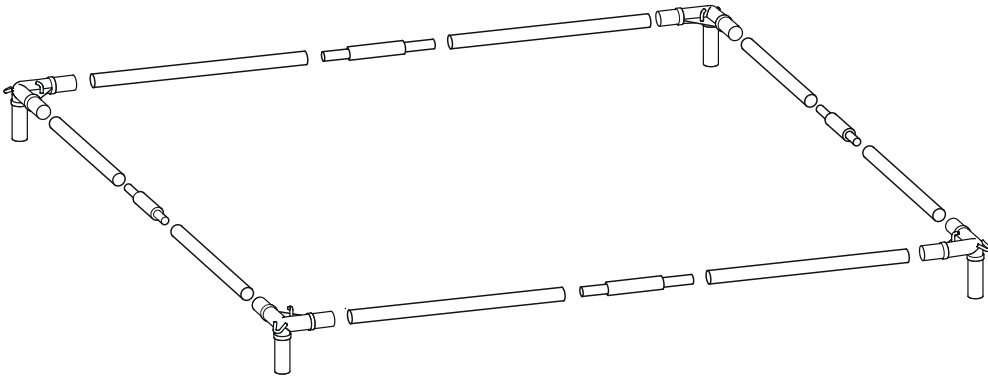

Step 1: Lay all the parts on the ground as shown.

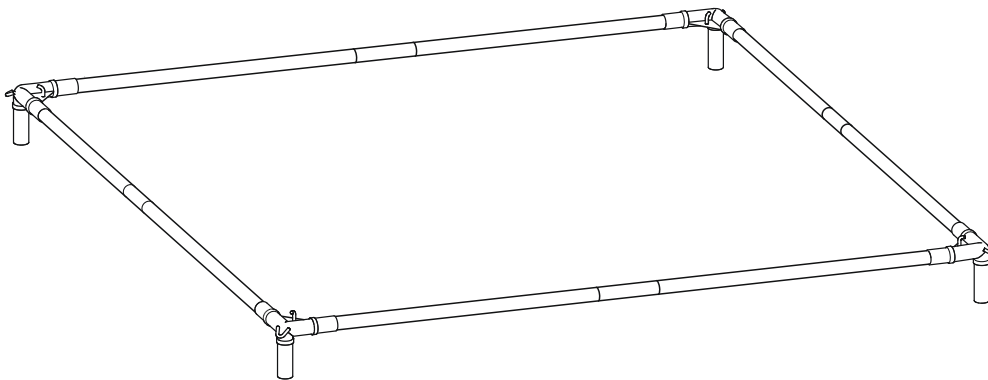

Step 2: Put all the joints and poles together.

Assembly

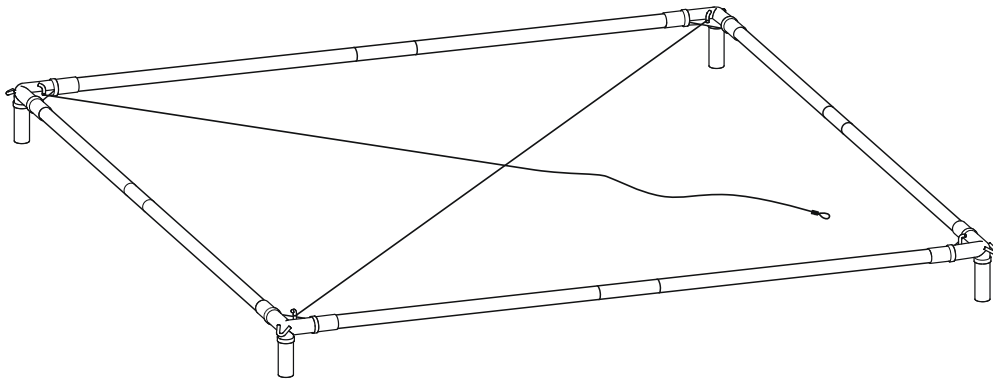

Step 3: Install one cross cable.

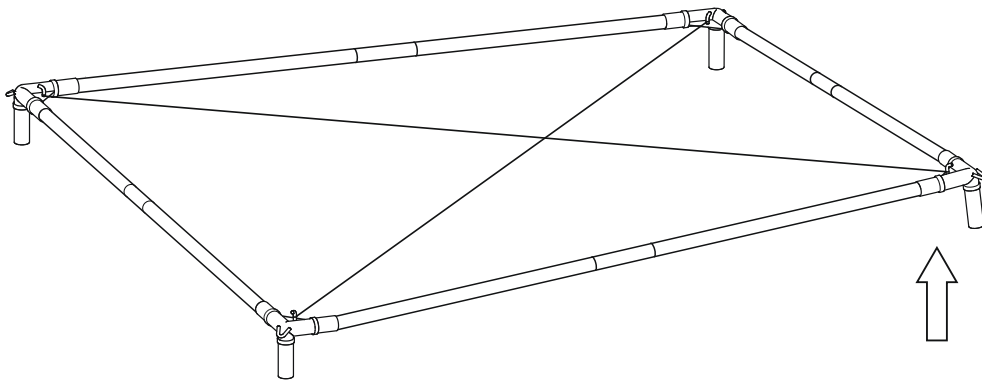

Step 4: Lift the left corner and suspend another cable.

Assembly

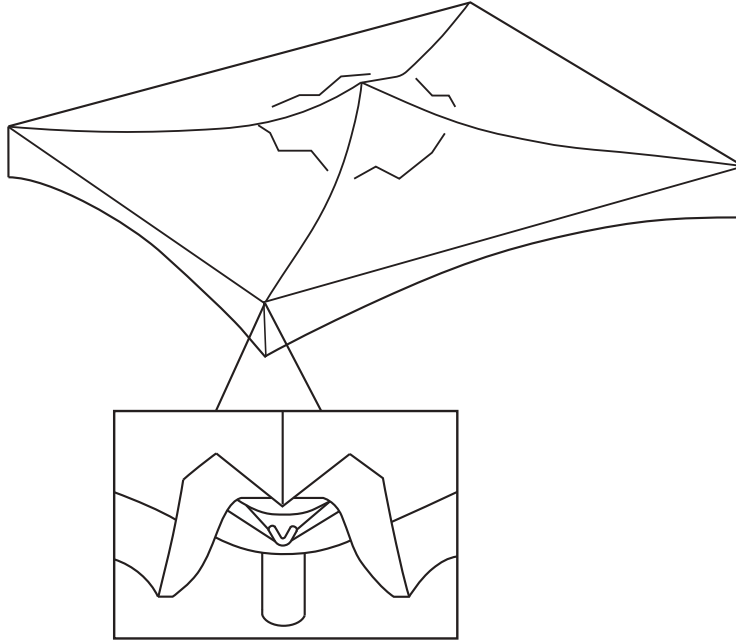

Step 5: Assembly the roof cover, pull the corner with handle.

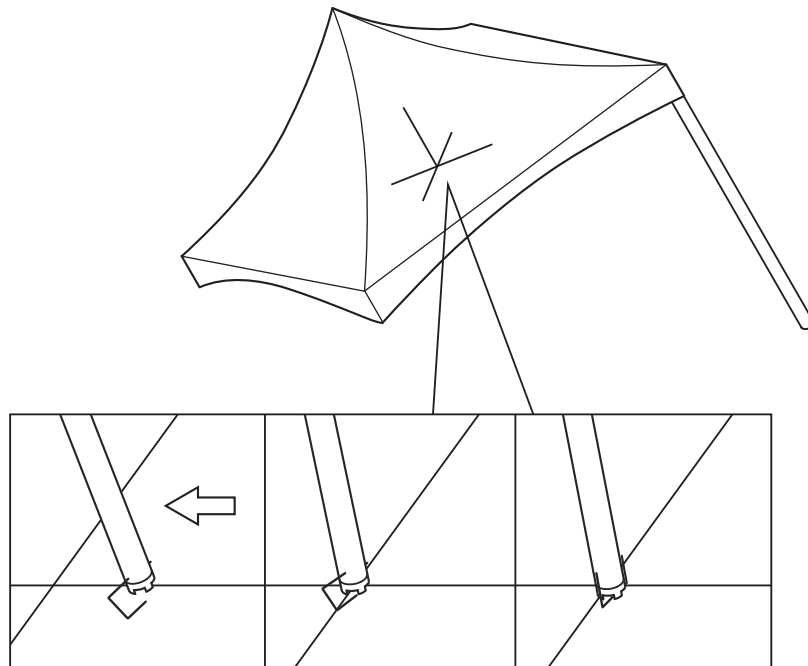

Step 6: Push the vertical pole upright.

Assembly

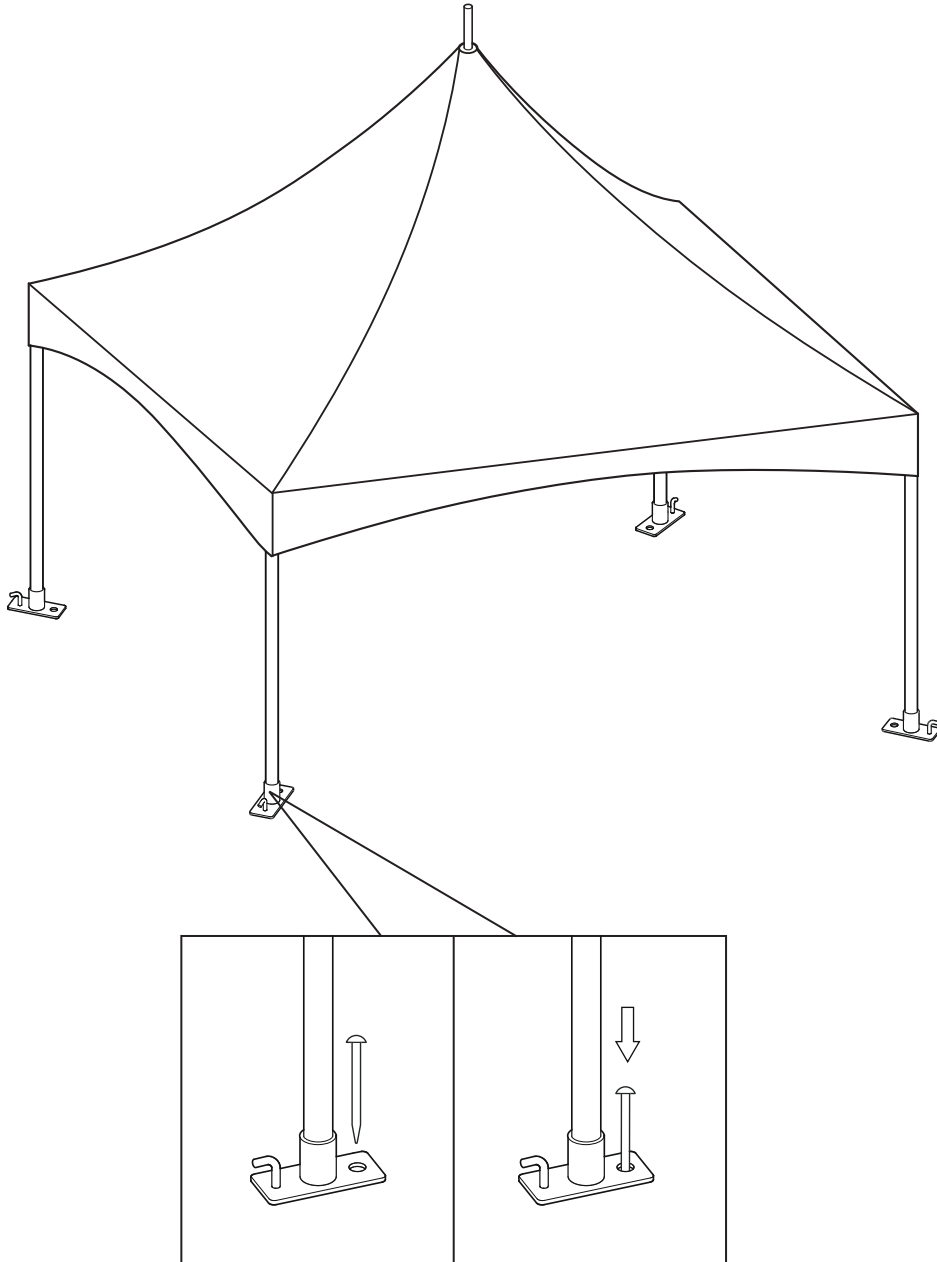

Step 7: Insert all the legs to make the tent stand up.

Note: use pegs to fix the tent on the ground

Assembly

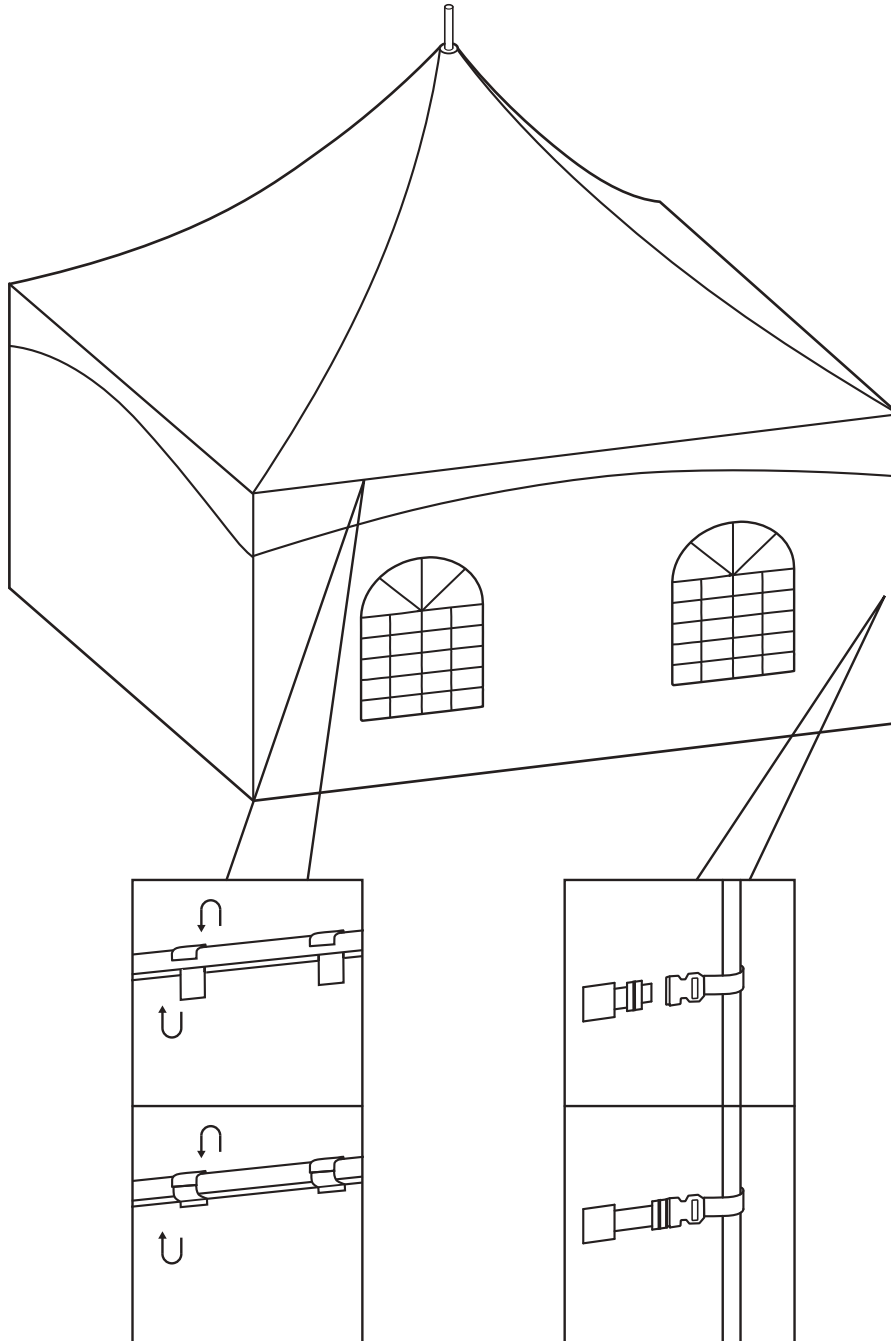

Step 8: Suspend all the sidewalls.

Note: use the buckles fix the sidewall on the frame

Assembly

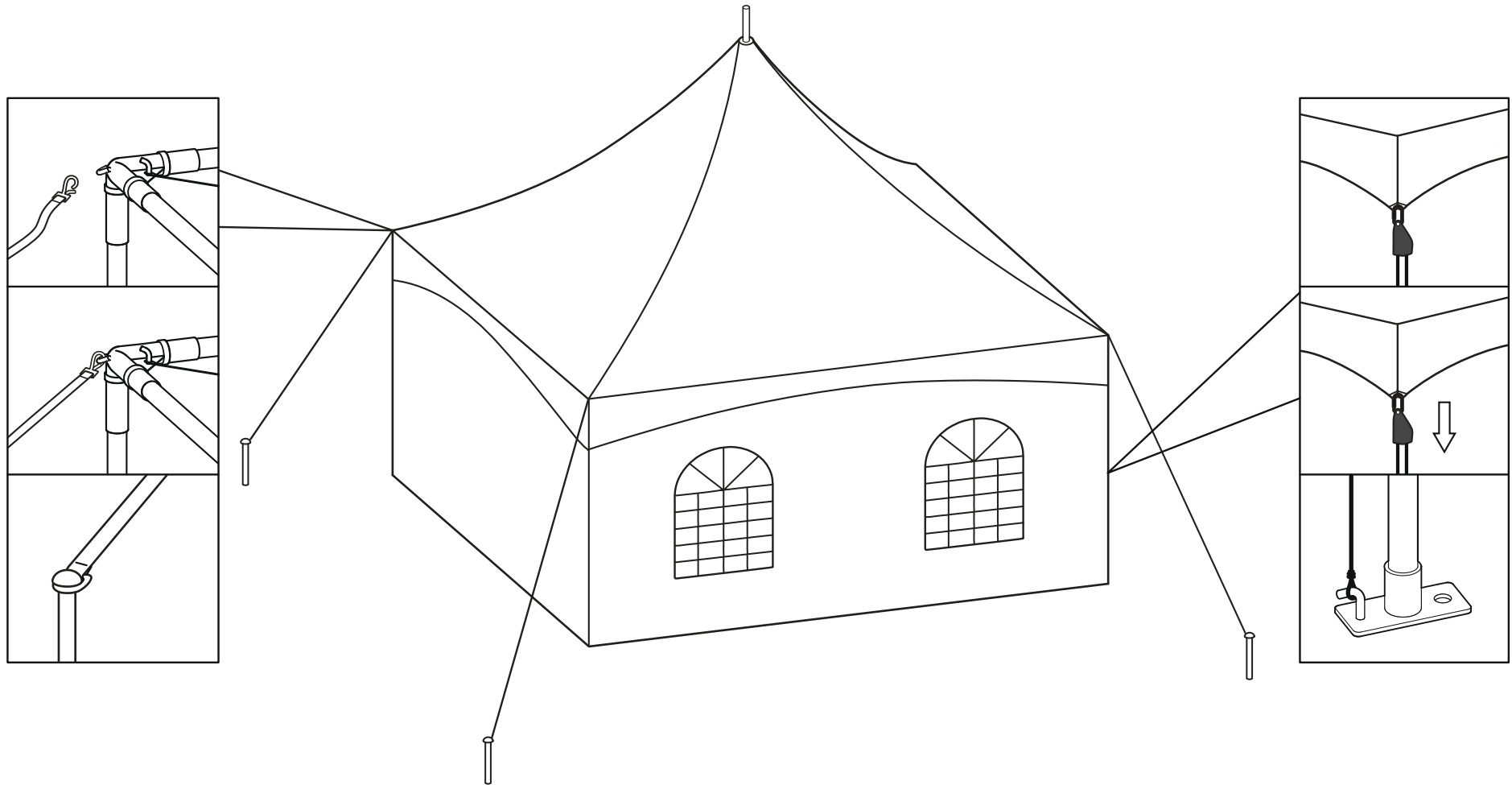

Step 9: Fasten the roof tensioning ropes and use the roof tensioning straps make the tent more stable.

DANCOVER[®]

.com

Contact information

Head office:

Dancover A/S
Nordre Strandvej 119 G
3150 Hellebæk
Denmark

For more information
please visit:
www.dancovershop.com

National contact

Denmark: 70 26 76 20
denmark@dancover.com

UK: 020 8099 7570
uk@dancover.com

Germany: 041 0266 7040
germany@dancover.com

France: 0975 181 800
france@dancover.com

Sweden: 040 233 262
sverige@dancover.com

Finland: 0 931 581 720
suomi@dancover.com

Poland: 22 300 8602
polska@dancover.com

Luxembourg: +49 041 0266 7040
luxembourg@dancover.com

Portugal: 308 800 899
portugal@dancover.com

Spain: 911 436 828
espana@dancover.com

Italy: 02 479 21 198
italia@dancover.com

Switzerland: 0840 000125
schweiz@dancover.com

Austria: 0662 626935
austria@dancover.com

Norway: 231 00 690
norge@dancover.com

Nederland: 0 858 880 524
nederland@dancover.com

Ireland: 0 151 33 003
ireland@dancover.com

Belgium: 0 28 08 08 09
belgique@dancover.com