

DANCOVER[®]



Marquee Partyzone
4x4m PVC

DANCOVER[®]



Safety Advice

Attention

In some countries approval is needed to set up a tent larger than 75 m².

The owner of the tent has the sole responsibility to make sure that these local rules are followed and that the mounting is correct.

In case of bad weather conditions, it is your responsibility to ensure that people inside are safe and that the tent does not cause damage to others.

Do not use open fire, welding equipment or other ignition sources in the tent. Though the fabric is made of flame retardant material it can still burn.











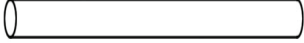

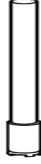

It is always recommended that you secure your tent properly with safety straps and augers when you put up the structure.

We recommend you to insure the tent, or check if it is covered by home contents insurance, in case of unplanned events, accidents or bad weather.

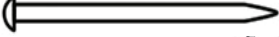
Tents are meant as temporary shelter and must be evacuated under extreme weather conditions.

This structure is not tested for specific snow and wind loads. That's why we always recommend to remove snow from the top.

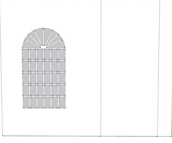
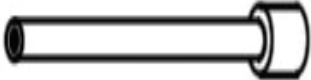
Part List

 1.		 2.		 3.		 4.	
Horizontal Pole	8Pcs	Leg	4Pcs	Vertical pole	1Pcs	Connector A	4Pcs
 5.		 6.		 7.		 8.	
Connector B	4Pcs	Connector C	4Pcs	Wire	2Pcs	Rope with clamp	4Pcs
 9.		 10.		 11.		 12.	
Stake Peg	8Pcs	roof tensioning rope	4Pcs	Roof Cover	1Pcs	Sidewall W/ Window	3Pcs
 13.		 14.		 15.			
Sidewall w/ Door	1Pcs	Roof pipe, Flagpole	1Pcs	roof tensioning strape	4Pcs		
						23-01-2013	
						DANCOVER®	

Frame sketch

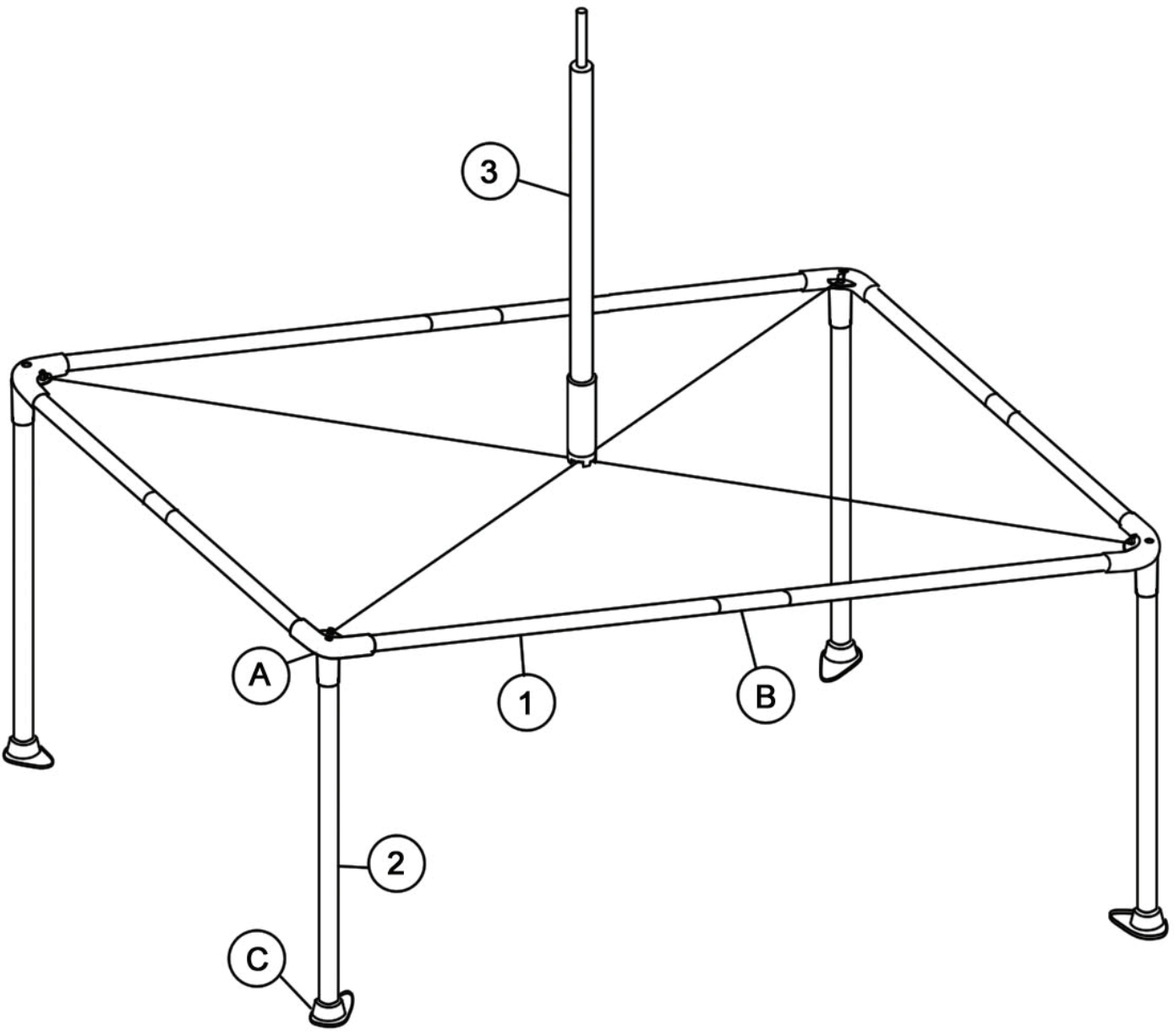

Assembly

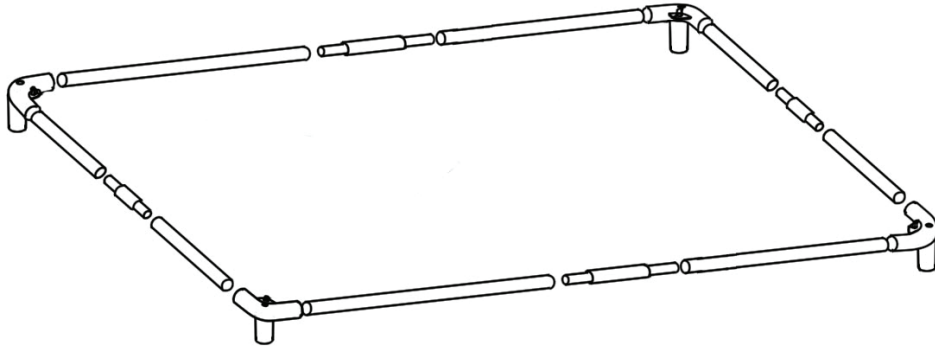

Step 1: Lay all the parts on the ground as shown.

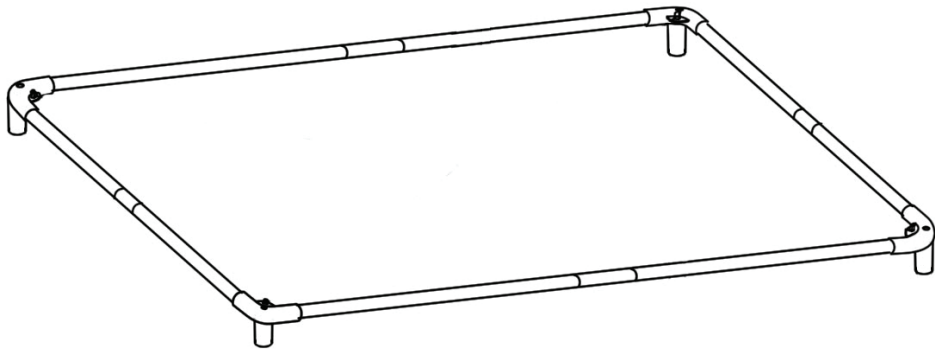

Step 2: Put all the joints and poles together.

Assembly

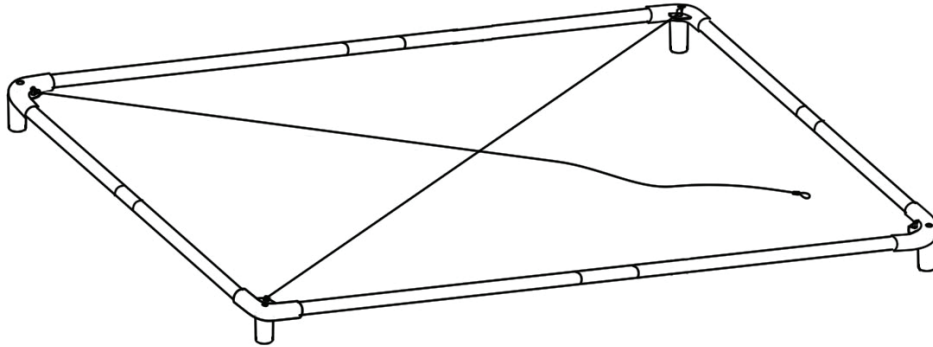

Step 3: Install one cross cable.

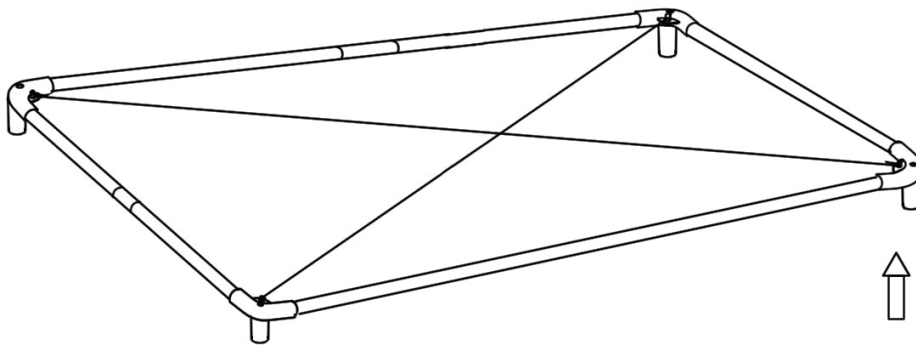

Step 4: Lift the left corner and suspend another cable.

Assembly

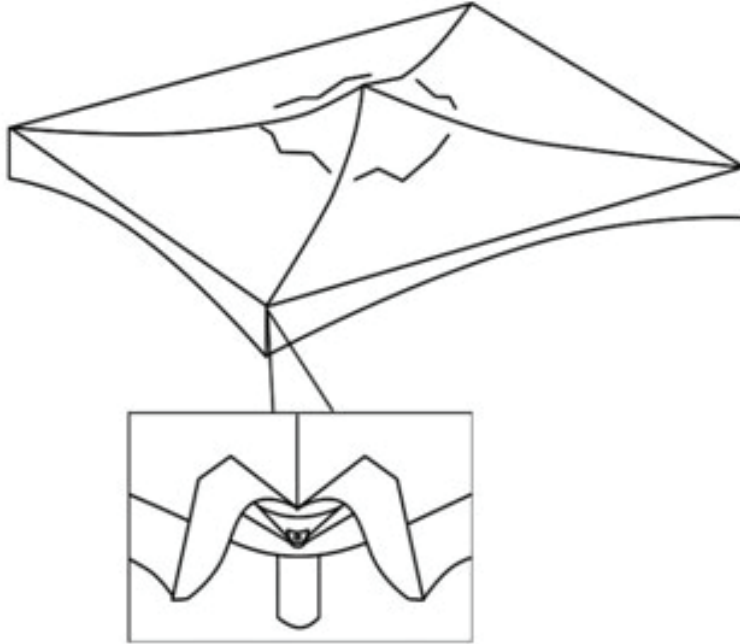

Step 5: Assembly the roof cover, pull the corner with handle.

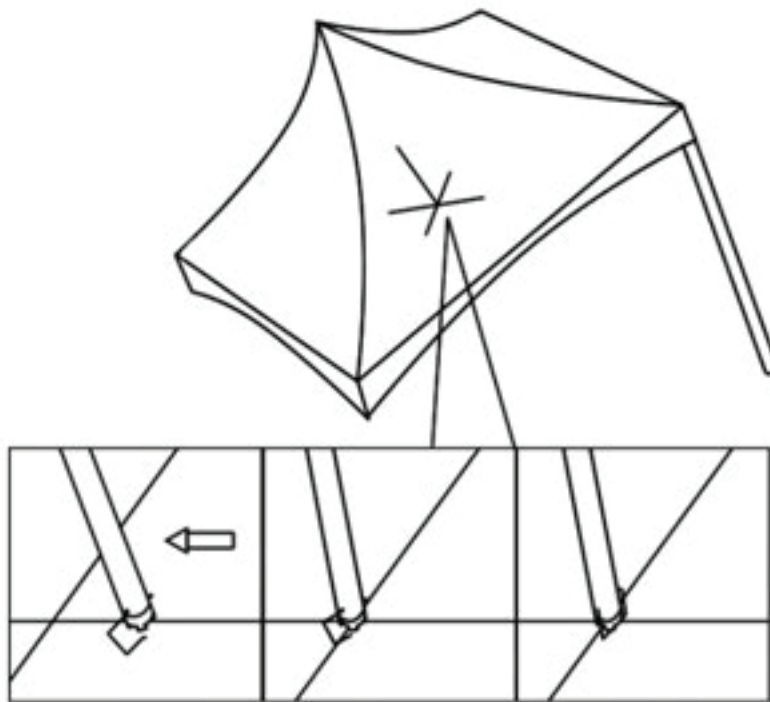

Step 6: Push the vertical pole upright.

Assembly

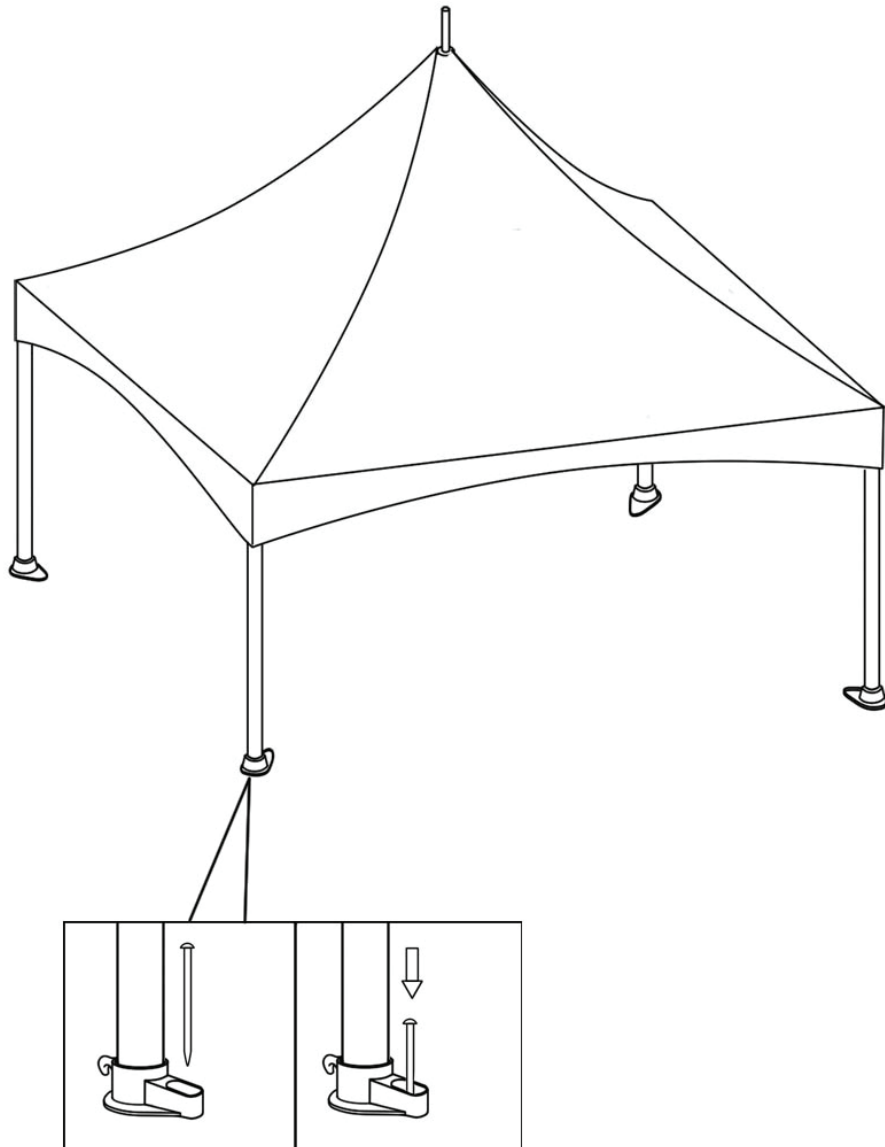

Step 7: Insert all the legs to make the tent stand up.

Note: use pegs to fix the tent on the ground

Assembly

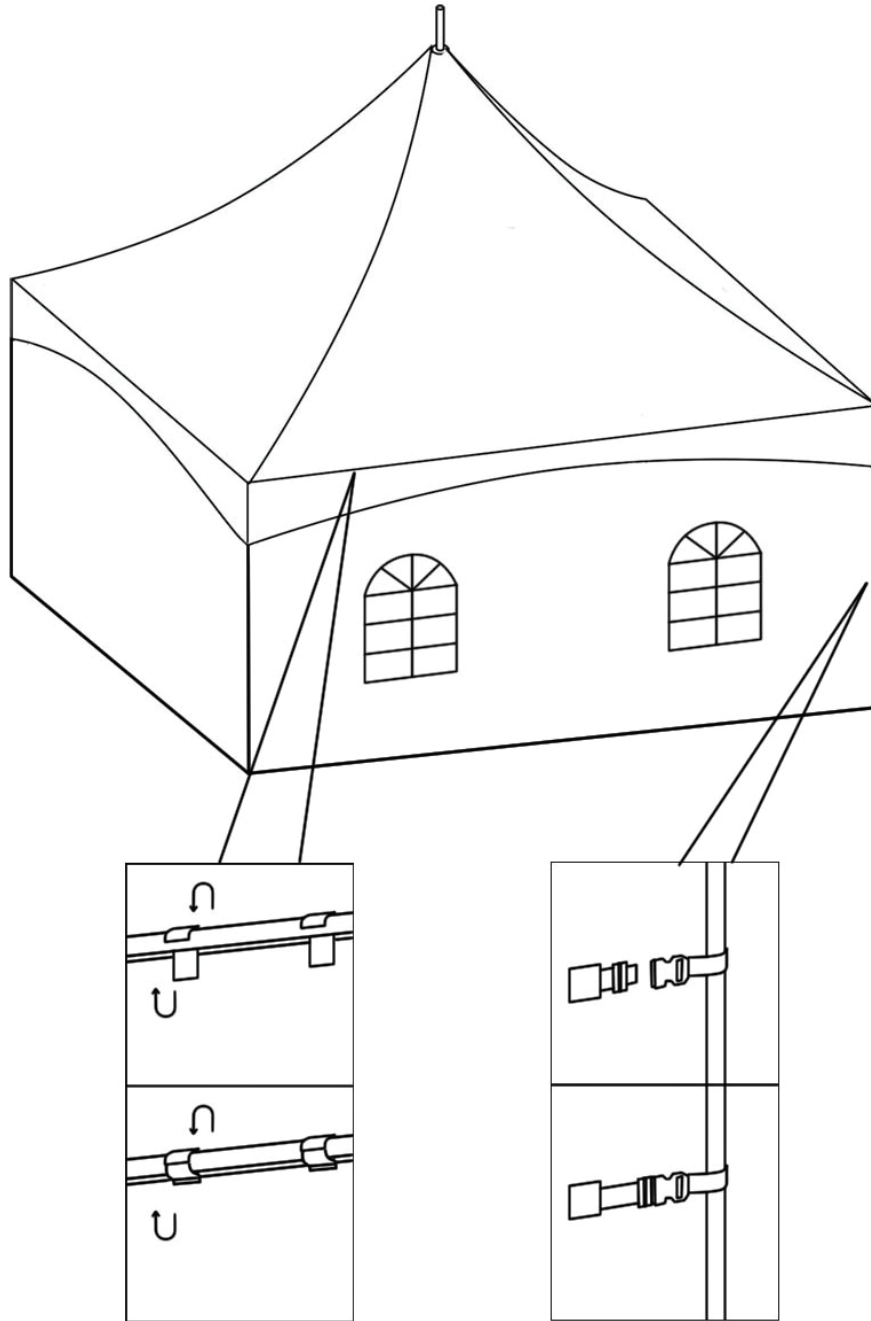

Step 8: Suspend all the sidewalls.

Note: use the buckles fix the sidewall on the frame

Assembly

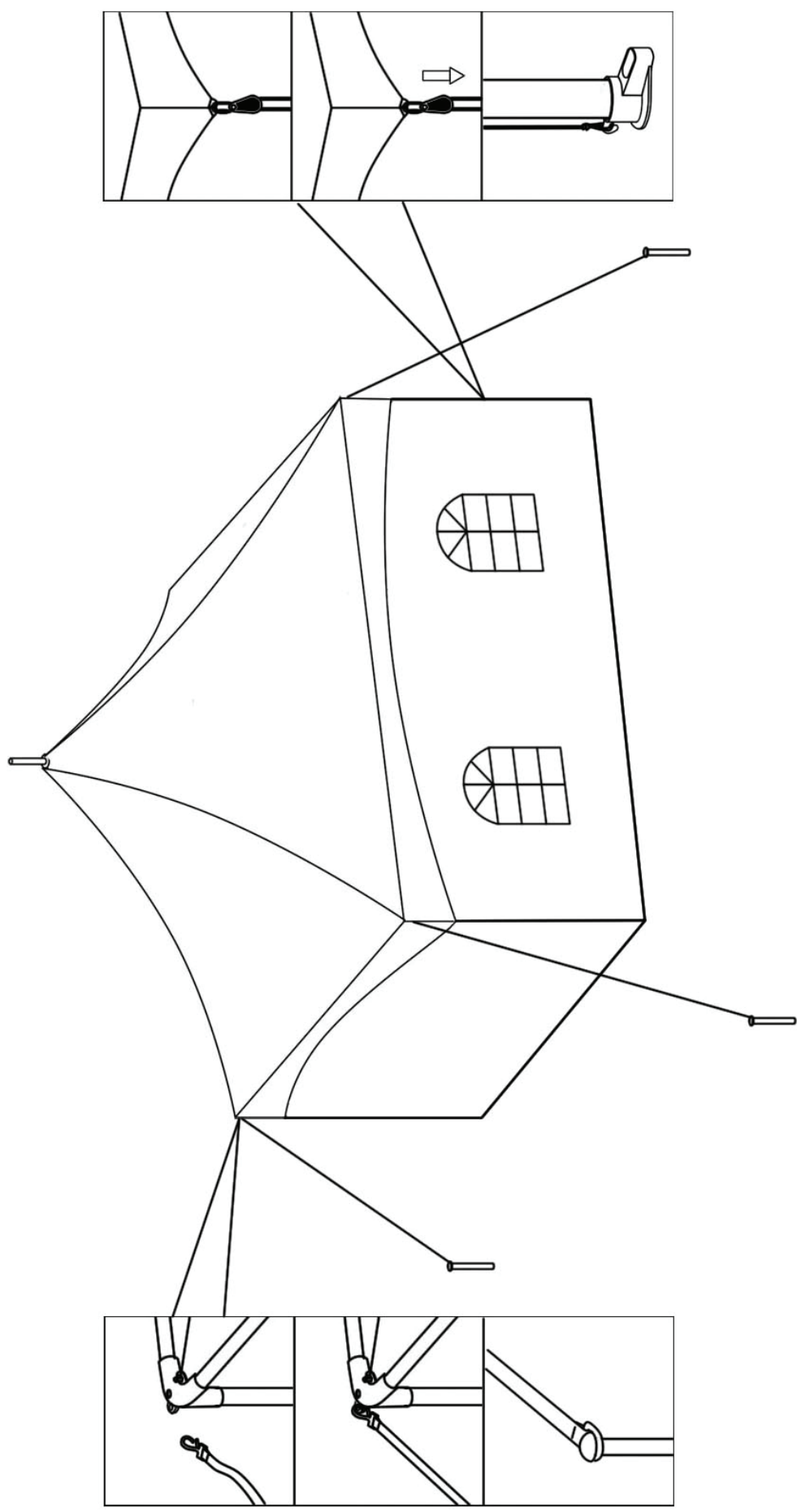

Step 9: Fasten the roof tensioning ropes and use the roof tensioning straps make the tent more stable.

Contact information

Head office:

Dancover A/S
Nordre Strandvej 119 G
3150 Hellebæk
Denmark

For more information
please visit:
www.dancovershop.com

National contact

Denmark:
denmark@dancover.com

UK:
uk@dancover.com

Germany:
germany@dancover.com

France:
france@dancover.com

Sweden:
sverige@dancover.com

Finland:
suomi@dancover.com

Poland:
polska@dancover.com

Luxembourg:
luxembourg@dancover.com

Spain:
espana@dancover.com

Italy:
italia@dancover.com

Switzerland:
schweiz@dancover.com

Austria:
austria@dancover.com

Norway:
norge@dancover.com

Nederland:
nederland@dancover.com

Ireland:
ireland@dancover.com

Belgium:
belgique@dancover.com